

Description and Purpose

A silt fence is made of a woven geotextile that has been entrenched, attached to supporting poles, and sometimes backed by a plastic or wire mesh for support. The silt fence detains water, promoting sedimentation of coarse sediment behind the fence. Silt fence does not retain soil fine particles like clays or silts.

Suitable Applications

Silt fences are suitable for perimeter control, placed below areas where sheet flows discharge from the site. They could also be used as interior controls below disturbed areas where runoff may occur in the form of sheet and rill erosion and around inlets within disturbed areas (SE-10). Silt fences should not be used in locations where the flow is concentrated. Silt fences should always be used in combination with erosion controls. Suitable applications include:

- At perimeter of a project.
- Below the toe or down slope of exposed and erodible slopes.
- Along streams and channels.
- Around temporary spoil areas and stockpiles.
- Around inlets.
- Below other small cleared areas.

Categories

EC	Erosion Control	
SE	Sediment Control	<input checked="" type="checkbox"/>
TC	Tracking Control	
WE	Wind Erosion Control	
NS	Non-Stormwater Management Control	
WM	Waste Management and Materials Pollution Control	

Legend:

- Primary Category**
- Secondary Category**

Targeted Constituents

Sediment (coarse sediment)	<input checked="" type="checkbox"/>
Nutrients	
Trash	
Metals	
Bacteria	
Oil and Grease	
Organics	

Potential Alternatives

- SE-5 Fiber Rolls
- SE-6 Gravel Bag Berm SE-12 Manufactured Linear Sediment Controls
- SE-13 Compost Socks and Berms
- SE-14 Biofilter Bags

If User/Subscriber modifies this fact sheet in any way, the CASQA name/logo and footer below must be removed from each page and not appear on the modified version.



Limitations

- Do not use in streams, channels, drain inlets, or anywhere flow is concentrated.
- Do not use in locations where ponded water may cause a flooding hazard.
- Do not use silt fence to divert water flows or place across any contour line.
- Improperly installed fences are subject to failure from undercutting, overtopping, or collapsing.
- Must be trenched and keyed in.
- Not intended for use as a substitute for Fiber Rolls (SE-5), when fiber rolls are being used as a slope interruption device.
- Do not use on slopes subject to creeping, slumping, or landslides.

Implementation

General

A silt fence is a temporary sediment barrier consisting of woven geotextile stretched across and attached to supporting posts, trenched-in, and, depending upon the strength of fabric used, supported with plastic or wire mesh fence. Silt fences trap coarse sediment by intercepting and detaining sediment-laden runoff from disturbed areas in order to promote sedimentation behind the fence.

The following layout and installation guidance can improve performance and should be followed:

- Silt fence should be used in combination with erosion controls up-slope in order to provide the most effective sediment control.
- Silt fence alone is not effective at reducing turbidity. (Barrett and Malina, 2004)
- Designers should consider diverting sediment laden water to a temporary sediment basin or trap. (EPA, 2012)
- Use principally in areas where sheet flow occurs.
- Install along a level contour, so water does not pond more than 1.5 ft at any point along the silt fence.
- Provide sufficient room for runoff to pond behind the fence and to allow sediment removal equipment to pass between the silt fence and toes of slopes or other obstructions. About 1200 ft² of ponding area should be provided for every acre draining to the fence.
- Efficiency of silt fences is primarily dependent on the detention time of the runoff behind the control. (Barrett and Malina, 2004)
- The drainage area above any fence should not exceed a quarter of an acre. (Rule of Thumb- 100-feet of silt fence per 10,000 square feet of disturbed area.) (EPA 2012)

- The maximum length of slope draining to any point along the silt fence should be 100 ft per foot of silt fence.
- Turn the ends of the filter fence uphill to prevent stormwater from flowing around the fence.
- Leave an undisturbed or stabilized area immediately down slope from the fence where feasible.
- Silt fences should remain in place until the disturbed area draining to the silt fence is permanently stabilized, after which, the silt fence fabric and posts should be removed and properly disposed.
- J-Hooks, which have ends turning up the slope to break up long runs of fence and provide multiple storage areas that work like mini-retention areas, may be used to increase the effectiveness of silt fence.
- Be aware of local regulations regarding the type and installation requirements of silt fence, which may differ from those presented in this fact sheet.

Design and Layout

In areas where high winds are anticipated the fence should be supported by a plastic or wire mesh. The geotextile fabric of the silt fence should contain ultraviolet inhibitors and stabilizers to provide longevity equivalent to the project life or replacement schedule.

- Layout in accordance with the attached figures.
- For slopes that contain a high number of rocks or large dirt clods that tend to dislodge, it may be necessary to protect silt fence from rocks (e.g., rockfall netting) ensure the integrity of the silt fence installation.

Standard vs. Heavy Duty Silt Fence

Standard Silt Fence

- Generally applicable in cases where the area draining to fence produces moderate sediment loads.

Heavy Duty Silt Fence

- Heavy duty silt fence usually has 1 or more of the following characteristics, not possessed by standard silt fence.
 - Fabric is reinforced with wire backing or additional support.
 - Posts are spaced closer than pre-manufactured, standard silt fence products.
- Use is generally limited to areas affected by high winds.
- Area draining to fence produces moderate sediment loads.

Materials

Standard Silt Fence

- Silt fence material should be woven geotextile with a minimum width of 36 in. The fabric should conform to the requirements in ASTM designation D6461.
- Wooden stakes should be commercial quality lumber of the size and shape shown on the plans. Each stake should be free from decay, splits or cracks longer than the

thickness of the stake or other defects that would weaken the stakes and cause the stakes to be structurally unsuitable.

- Staples used to fasten the fence fabric to the stakes should be not less than 1.75 in. long and should be fabricated from 15 gauge or heavier wire. The wire used to fasten the tops of the stakes together when joining two sections of fence should be 9 gauge or heavier wire. Galvanizing of the fastening wire will not be required.

Heavy-Duty Silt Fence

- Some silt fence has a wire backing to provide additional support, and there are products that may use prefabricated plastic holders for the silt fence and use metal posts instead of wood stakes.

Installation Guidelines – Traditional Method

Silt fences are to be constructed on a level contour. Sufficient area should exist behind the fence for ponding to occur without flooding or overtopping the fence.

- A trench should be excavated approximately 6 in. wide and 6 in. deep along the line of the proposed silt fence (trenches should not be excavated wider or deeper than necessary for proper silt fence installation).
- Bottom of the silt fence should be keyed-in a minimum of 12 in.
- Posts should be spaced a maximum of 6 ft apart and driven securely into the ground a minimum of 18 in. or 12 in. below the bottom of the trench.
- When standard strength geotextile is used, a plastic or wire mesh support fence should be fastened securely to the upslope side of posts using heavy-duty wire staples at least 1 in. long. The mesh should extend into the trench.
- When extra-strength geotextile and closer post spacing are used, the mesh support fence may be eliminated.
- Woven geotextile should be purchased in a long roll, then cut to the length of the barrier. When joints are necessary, geotextile should be spliced together only at a support post, with a minimum 6 in. overlap and both ends securely fastened to the post.
- The trench should be backfilled with native material and compacted.
- Construct the length of each reach so that the change in base elevation along the reach does not exceed 1/3 the height of the barrier; in no case should the reach exceed 500 ft.
- Cross barriers should be a minimum of 1/3 and a maximum of 1/2 the height of the linear barrier.
- See typical installation details at the end of this fact sheet.

Installation Guidelines - Static Slicing Method

- Static Slicing is defined as insertion of a narrow blade pulled behind a tractor, similar to a plow blade, at least 10 inches into the soil while at the same time pulling silt geotextile fabric into the ground through the opening created by the blade to the depth of the blade. Once the geotextile is installed, the soil is compacted using tractor tires.
- This method will not work with pre-fabricated, wire backed silt fence.
- Benefits:
 - Ease of installation (most often done with a 2 person crew).
 - Minimal soil disturbance.
 - Better level of compaction along fence, less susceptible to undercutting
 - Uniform installation.
- Limitations:
 - Does not work in shallow or rocky soils.
 - Complete removal of geotextile material after use is difficult.
 - Be cautious when digging near potential underground utilities.

Costs

- It should be noted that costs vary greatly across regions due to available supplies and labor costs.
- Average annual cost for installation using the traditional silt fence installation method (assumes 6 month useful life) is \$7 per linear foot based on vendor research. Range of cost is \$3.50 - \$9.10 per linear foot.

Inspection and Maintenance

- BMPs must be inspected in accordance with General Permit requirements for the associated project type and risk level. It is recommended that at a minimum, BMPs be inspected weekly, prior to forecasted rain events, daily during extended rain events, and after the conclusion of rain events.
- Repair undercut silt fences.
- Repair or replace split, torn, slumping, or weathered fabric. The lifespan of silt fence fabric is generally 5 to 8 months.
- Silt fences that are damaged and become unsuitable for the intended purpose should be removed from the site of work, disposed, and replaced with new silt fence barriers.
- Sediment that accumulates in the BMP should be periodically removed in order to maintain BMP effectiveness. Sediment should be removed when the sediment accumulation reaches 1/3 of the barrier height.
- Silt fences should be left in place until the upgradient area is permanently stabilized. Until then, the silt fence should be inspected and maintained regularly.

- Remove silt fence when upgradient areas are stabilized. Fill and compact post holes and anchor trench, remove sediment accumulation, grade fence alignment to blend with adjacent ground, and stabilize disturbed area.

References

Manual of Standards of Erosion and Sediment Control Measures, Association of Bay Area Governments, May 1995.

Monitoring Data on Effectiveness of Sediment Control Techniques, Proceedings of World Water and Environmental Resources Congress, Barrett M. and Malina J. 2004.

National Management Measures to Control Nonpoint Source Pollution from Urban Areas, United States Environmental Protection Agency, 2002.

Proposed Guidance Specifying Management Measures for Sources of Nonpoint Pollution in Coastal Waters, Work Group-Working Paper, USEPA, April 1992.

Sedimentation and Erosion Control Practices, and Inventory of Current Practices (Draft), USEPA, 1990.

Southeastern Wisconsin Regional Planning Commission (SWRPC). Costs of Urban Nonpoint Source Water Pollution Control Measures. Technical Report No. 31. Southeastern Wisconsin Regional Planning Commission, Waukesha, WI. 1991.

Stormwater Quality Handbooks - Construction Site Best Management Practices (BMPs) Manual, State of California Department of Transportation (Caltrans), March 2003.

Stormwater Management Manual for The Puget Sound Basin, Washington State Department of Ecology, Public Review Draft, 1991.

U.S. Environmental Protection Agency (USEPA). Stormwater Best Management Practices: Silt Fences. U.S. Environmental Protection Agency, Office of Water, Washington, DC, 2012.

U.S. Environmental Protection Agency (USEPA). Stormwater Management for Industrial Activities: Developing Pollution Prevention Plans and Best Management Practices. U.S. Environmental Protection Agency, Office of Water, Washington, DC, 1992.

Water Quality Management Plan for the Lake Tahoe Region, Volume II, Handbook of Management Practices, Tahoe Regional Planning Agency, November 1988.

Soil Stabilization BMP Research for Erosion and Sediment Controls: Cost Survey Technical Memorandum, State of California Department of Transportation (Caltrans), July 2007.

Erosion and Sediment Control Manual, Oregon Department of Environmental Quality, February 2005.

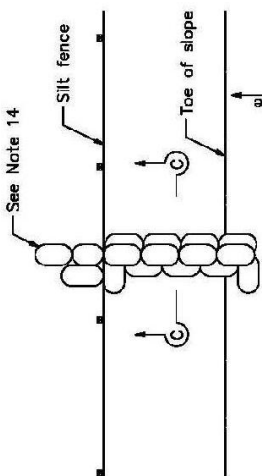
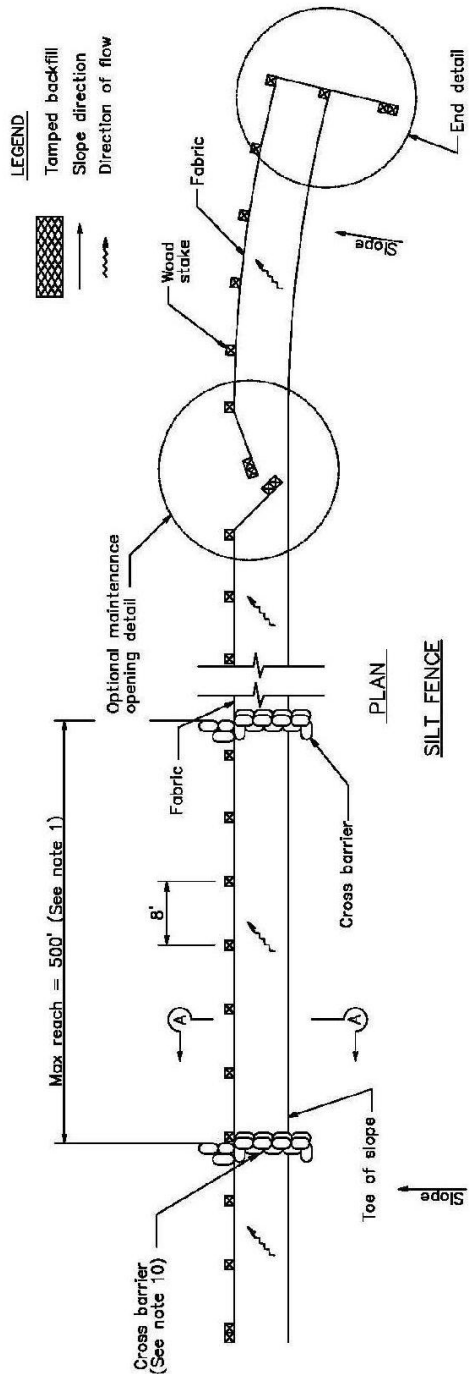

CROSS BARRIER DETAIL

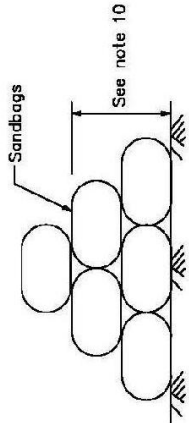

SECTION C-C

NOTES

1. Construct the length of each reach so that the change in base elevation along the reach does not exceed 1/3 the height of the linear barrier. In no case shall the reach length exceed 500.
2. The last 8'-0" of fence shall be turned up slope.
3. Stake dimensions are nominal.
4. Dimension may vary to fit field condition.
5. Stakes shall be spaced at 8'-0" maximum and shall be positioned on downstream side of fence.
6. Stakes to overlap and fence fabric to fold around each stake one full turn. Secure fabric to stake with 4 staples.
7. Stakes shall be driven tightly together to prevent potential flow-through of sediment at joint. The tops of the stakes shall be secured with wire.
8. For end stake, fence fabric shall be folded around two stakes one full turn and secured with 4 staples.
9. Minimum 4 staples per stake. Dimensions shown are typical.
10. Cross barriers shall be a minimum of 1/3 and a maximum of 1/2 the height of the linear barrier.
11. Maintenance openings shall be constructed in a manner to ensure sediment remains behind silt fence.
12. Joining sections shall not be placed at sump locations.
13. Sandbag rows and layers shall be offset to eliminate gaps.
14. Add 3-4 bags to cross barrier on downgradient side of silt fence as needed to prevent bypass or undermining and as allowable based on site limits of disturbance.

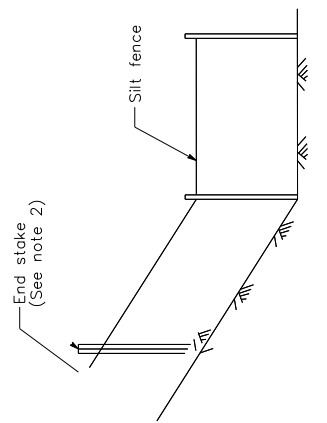
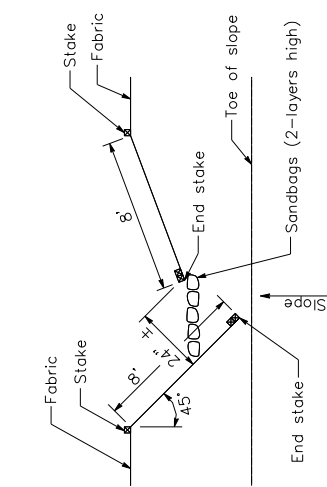
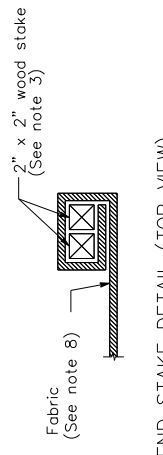
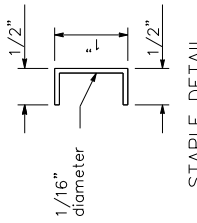
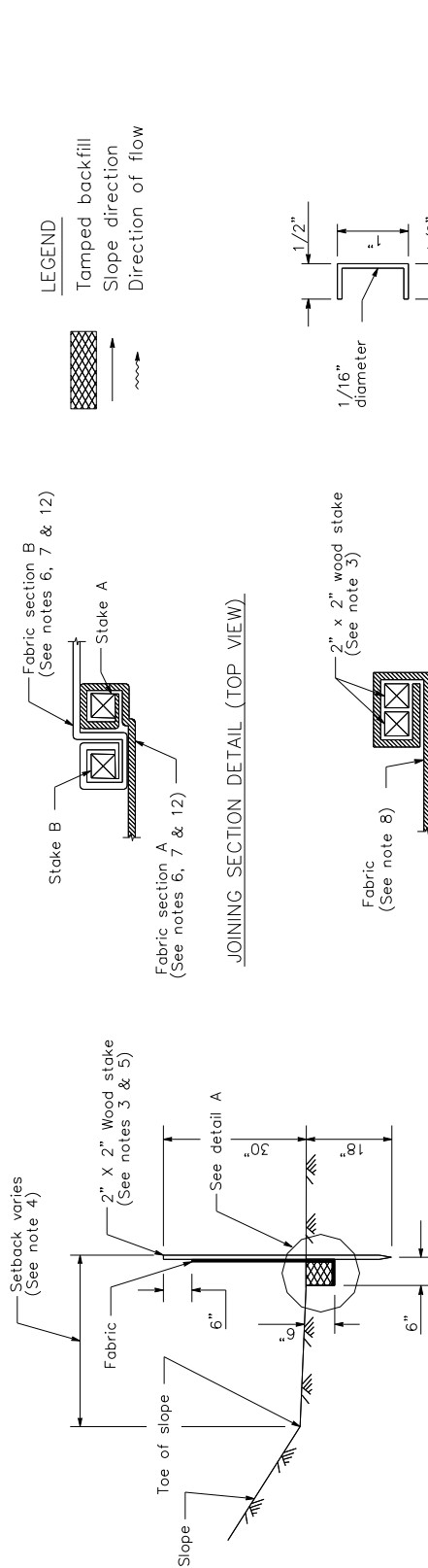

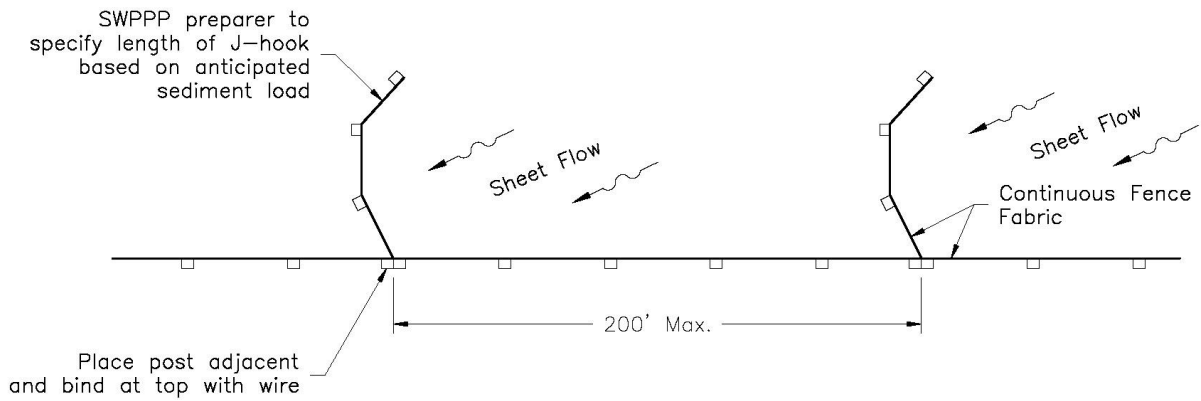

Plan

J-HOOK