

**COUNTY OF SAN MATEO
PLANNING AND BUILDING DEPARTMENT**

DATE: June 26, 2024

TO: Planning Commission

FROM: Planning Staff

SUBJECT: EXECUTIVE SUMMARY: Consideration of a Coastal Development Permit, Use Permit, Variance, and Design Review Permit, pursuant to Sections 6328.4, 6500, 6530, and 6565.3, respectively, of the San Mateo County Zoning Regulations, and a Grading Permit, pursuant to Section 9283 of the County Ordinance Code, for the construction of a new 10,178 sq. ft. fire station to replace the existing Fire Station 44, located at 501 Stetson Street in the unincorporated Moss Beach area of San Mateo County. A Variance is requested for a reduction in the front setback and an exceedance of the maximum floor area of the zoning district. The project is appealable to the California Coastal Commission. In conjunction with the requested permits, it is recommended that the Planning Commission determine that the project is categorically exempt from California Environmental Quality Act (CEQA) pursuant to CEQA Guidelines Section 15302.

County File Number: PLN2023-00311 (Coastside Fire Protection District/Duncklee)

PROPOSAL

The applicant, Coastside Fire Protection District (CFPD), proposes the construction of a new fire station to replace the existing 3,100 sq. ft. Fire Station 44 at 501 Stetson Street, Moss Beach. The proposed fire station includes two (2) drive-through apparatus bays, staff living quarters with 5 bedrooms, offices, a fitness room, and a training room. The new station would continue to operate with existing staff at levels equivalent to the existing station. Two (2) new driveways along Stetson Street would provide access for the fire apparatus bays and the parking area for fire station employees. The southern driveway would provide exclusive access for firefighting and emergency vehicles. The project also includes a paved walkway with an ADA-compliant ramp leading to the entrance of the fire station. The project involves a total of 1,929 cubic yards (c.y.) of grading (cut: 1,820 c.y.; fill: 109 c.y.) and no tree removal.

Construction of the new fire station is expected to start in January 2026 and last approximately 18 months, with site preparation (i.e., grading, utility trenches, retaining walls) that would last approximately two months. While the construction is underway,

fire protection services would be located within a new temporary station adjacent to the Moss Beach Sheriff station on Etheldore Street (PLN 2024-00033). Upon completion of the new fire station, the temporary station will be removed, and the site would be restored to its existing condition.

RECOMMENDATION

That the Planning Commission approve the Coastal Development Permit, Use Permit, Variance, Design Review, and Grading Permit, PLN2023-00311, by making the required findings and adopting the conditions of approval in Attachment A.

SUMMARY

Conformance with the General Plan Policies

The project complies with applicable General Plan policies, including Policy 4.15 (*Appearance of New Development*), Policy 4.21 (*Utility Structures*), Policy 4.36 (*Urban Area Design Concept*), Policy 7.2 (*Preserving Community Character*), Policy 8.30 (Infilling), and Policy 12.21 (*Local Circulation Policies*). This is achieved by fulfilling design review guidelines, maintaining the station's location in a developed neighborhood, having adequate access to water and sewer services, and avoiding impacts on the existing local traffic patterns.

Conformance with the Local Coastal Program Policies

The project complies with applicable Local Coastal Program (LCP) policies, including but not limited to Policy 1.19 (*Ensure Adequate Public Services and Infrastructure for New Development in Urban Areas*), Policy 8.12(a)(1) (*General Regulations*), Policy 8.13 (*Special Design Guidelines for Coastal Communities*), and Policy 8.13 (*Special Design Guidelines for Coastal Communities*). The project will be provided with adequate public water and sewage services, is a compatible and established use within the neighborhood, minimizes impacts on visual resources, and is consistent with design guidelines.

Conformance with the Half Moon Bay Airport Land Use Compatibility Plan

Staff has reviewed the projects and concluded that the project is in compliance with the policies. The project is located in Zone 4, as designated by the Half Moon Bay Airport Land Use Compatibility Plan, where public uses, such as a fire station, are not prohibited.

Conformance with the S-17 Zoning District Development Standards

The proposed fire station complies with applicable development standards, except for the maximum building floor area and front setback. The applicant requests a Variance for exceptions to zoning development standards for building floor area and front setback to ensure full functionality of the proposed fire station.

Conformance with Use Permit Findings

The proposed fire station is intended to meet the current and future needs for emergency services of the area and will not result in a significant adverse impact to coastal resources or be detrimental to the public welfare or injurious to property or improvements in said neighborhood.

Conformance with Design Review District Standards

The proposed two-story fire station complies with Section 6565.17 of the Zoning Regulations as it is designed to follow the natural topography of the project site, minimize visual impacts on the area, avoid the creation drainage or erosion problems, and be compatible with other development in the area.

Conformance with Variance Findings

The proposed front setback reduction is necessary to ensure full functionality of the proposed fire station and to meet the current and future needs for emergency services of the area. Approval of the variance will not grant the landowner a special privilege because the requested exceptions are necessary to ensure full functionality of the fire station, which is an existing use and essential to the safety of the community.

**COUNTY OF SAN MATEO
PLANNING AND BUILDING DEPARTMENT**

DATE: June 26, 2024

TO: Planning Commission

FROM: Planning Staff

SUBJECT: Consideration of a Coastal Development Permit, Use Permit, Variance, and Design Review Permit, pursuant to Sections 6328.4, 6500, 6530, and 6565.3, respectively, of the San Mateo County Zoning Regulations, and a Grading Permit, pursuant to Section 9283 of the County Ordinance Code, for the construction of a new 10,178 sq. ft. fire station to replace the existing Fire Station 44, on a 21,695 sq. ft. property located at 501 Stetson Street in the unincorporated Moss Beach area of San Mateo County. A Variance is requested for a reduction in the front setback and an exceedance of the maximum floor area of the zoning district. The project is appealable to the California Coastal Commission. In conjunction with the requested permits, it is recommended that the Planning Commission determine that the project is categorically exempt from California Environmental Quality Act (CEQA) pursuant to CEQA Guidelines Section 15302.

County File Number: PLN 2023-00311 (Coastside Fire Protection District/Duncklee)

PROPOSAL

The applicant, Coastside Fire Protection District (CFPD), proposes the construction of a new fire station to replace the existing 3,100 sq. ft. Fire Station 44 at 501 Stetson Street, Moss Beach. The proposed fire station includes two (2) drive-through apparatus bays, staff living quarters with five (5) bedrooms, offices, a fitness room, and a training room. The new station would continue to operate with existing staff at levels equivalent to the existing station. Two (2) new driveways along Stetson Street would provide access for the fire apparatus bays and the parking area for fire station employees. The southern driveway would provide exclusive access for firefighting and emergency vehicles. The project also includes a paved walkway with an ADA-compliant ramp leading to the entrance of the fire station building for visitors and staff. The project involves a total of 1,929 cubic yards (c.y.) of grading (cut: 1,820 c.y.; fill: 109 c.y.) and no tree removal.

Construction of the new fire station is expected to start in January 2026 and last a total of approximately 18 months, with site preparation (i.e., grading, utility trenches, retaining walls) that would last approximately two months. While the construction is underway, fire protection services would be located within a new temporary station adjacent to the Moss Beach Sheriff station on Etheldore Street (PLN2024-00033). Upon completion of

the new fire station, the temporary station will be removed, and the site would be restored.

RECOMMENDATION

That the Planning Commission approve the Coastal Development Permit, Use Permit, Variance, Design Review, and Grading Permit, PLN 2023-00311, by making the required findings and adopting the conditions of approval in Attachment A.

BACKGROUND

Report Prepared By: Glen Jia, Project Planner; 650/363-1803

Applicant: Austin Duncklee of PDK Architects Inc.

Owner: Coastside Fire Protection District (CFPD)

Location: 501 Stetson Street, Moss Beach

APN: 037-063-380

Size: 21,695 sq. ft.

Existing Zoning: R-1/S-17/DR/CD (One Family Residential District/Residential Density District 17/Design Review District/Coastal Development District)

General Plan Land Use Designation/Local Coastal Program Designation: Medium Density Residential

Sphere-of-Influence: City of Half Moon Bay

Existing Land Use: Fire Station

Water Supply: Montara Water and Sanitary District

Sewage Disposal: Montara Water and Sanitary District

Flood Zone: Zone X (area of minimal flood), FEMA Community Panel 06081C0117F, effective August 2, 2017

Environmental Evaluation: This project is exempt from environmental review pursuant to the California Environmental Quality Act (CEQA) Guidelines Section 15302, Class 2, relating to the replacement or reconstruction of existing structures where the new structure will be located on the same site as the structure replaced and will have substantially the same purpose and capacity as the structure replaced. According to the applicant, the proposed fire station, despite its increase in floor area, will retain the same capacity in terms of number of employees and operational scope and capabilities

(two (2) apparatus bays). Further, the new fire station would be constructed within a previously disturbed area of the parcel. For these reasons, the project is exempt from the California Environmental Quality Act.

Setting: The subject property is developed with an existing fire station containing two (2) apparatus bays. It is a pie-shape parcel that fronts two streets, located east of Cabrillo Highway (State Route 1) in the unincorporated community of Moss Beach. The parcel is bounded by Stetson Street to the southwest and Sierra Street to the northeast. The parcel will only be accessed from Stetson Street during construction, due to a high slope/berm at Sierra Street. The parcel is relatively flat within the development area. The site is located within a residential neighborhood and does not contain sensitive habitat.

Chronology:

<u>Date</u>	-	<u>Action</u>
October 23, 2023	-	Application submitted for the construction of a new fire station.
November 20, 2023	-	Project deemed incomplete due to compliance issues with zoning and design review, and the need to address comments from the Department of Public Works.
May 22, 2024	-	Project review by the Midcoast Community Council (MCC) at their regularly scheduled public meeting. Agenda also includes review of the proposed temporary fire station on Eltheldore Street (PLN2024-00033). Members of the public expressed concerns regarding public health (noise and hazardous fumes), building floor area, exterior colors, light spill, and site suitability (See Section B for further Discussion.
June 26, 2024	-	Planning Commission hearing. In addition to review of the subject project, meeting agenda includes review of the proposed temporary fire station on Eltheldore Street (PLN2024-00033).

DISCUSSION

A. KEY ISSUES

1. Conformance with the General Plan and Montara-Moss Beach-El Granada Area Plan

Staff has reviewed and determined that the project complies with all of the applicable General Plan Policies and Area Plan Policies, including the following:

a. Visual Quality Policies

Policy 4.15 (*Appearance of New Development*), Policy 4.21 (*Utility Structures*), and Policy 4.36 (*Urban Area Design Concept*) of the General Plan; and Policy 7.2 (*Preserving Community Character*) of the Montara-Moss Beach-El Granada Area Plan seek to promote and enhance good design, site relationships and other aesthetic considerations to maintain community character and ensure that new development is compatible with the residential community in terms of scale, size and design; minimize the adverse visual quality of utility structures; and ensure that new development is designed and constructed to contribute to the orderly and harmonious development of the locality.

The parcel is located within the County scenic corridor of the Cabrillo Highway and is adjacent to existing residential development. While the one-story fire station would be replaced with a two-story fire station, the project would result in a negligible impact on the views from the Highway 1 (located approx. 320 feet to the west) due to intervening streets and development.

Due to the features required to effectively accommodate modern firefighting apparatus and facilities, the proposed building would be larger in scale than immediately adjoining development. Accordingly, the 10,178 sq. ft. new station requires a Variance for a reduced front setback, as well as for an additional 7,078 sq. ft. of floor area beyond the maximum allowed in the S-17 Zoning District. Impacts would be somewhat reduced due to the terrain and existing adjacent buildings of varying sizes. In order to minimize impacts to nearby residential properties the applicant proposes larger side setbacks of 15 feet (right) and 21 feet (left), where 5 and 10 feet are required, to reduce impacts on the neighboring properties. The applicant proposes a variety of shrubs and ground covering plants in the front and side setbacks, which will soften views from adjoining residential development.

In accordance with design standards, the applicant has incorporated earth-tone colors to soften the appearance of the building, reduced the height of the building, and revised the lighting plan to minimize spillover lighting. The applicant has agreed to revise the project from a height of 32 feet 3 inches to comply with the 28 feet maximum height limit, as required by Condition 3. Regarding lighting, the

applicant proposes new wall-mounted lighting fixtures and four (4) light poles near the property boundary, which would allow for greater illumination of the site from the current condition but would result in spillover lighting to adjoining properties and Stetson Street.

The applicant acknowledged the feedback received from staff and the Midcoast Community Council regarding spillover and night-sky impacts. As shown on the site lighting plan (Sheet E1.1), the updated design features fully dimmable lighting, with the ability to operate on a timer to prevent unwanted illumination during dark hours.

Additionally, the project employs a dual head approach where warm lighting colors will be utilized under normal circumstances, with the option to activate cooler light colors only in emergencies. This offers flexibility and functionality to the fire district while minimizing light spillover. Site lighting has also been reduced with specific adjustments such as replacing a light to the left of the northern driveway with a light bollard and utilizing a high berm to prevent light spill onto neighboring properties. Condition 18 requires compliance with the revised Lighting Plan at the time of building permit submittal, as well as provision of foot candle measurements at every property line. The foot candle measurement shall be consistent with the revised Lighting Plan. Any further lighting spillover is subject to the review and approval of the Director of Planning and Building.

With this condition and the changes made to the original design, the project complies with General Plan Visual Quality policies.

b. Wastewater Policies

Policy 8.30 (*Infilling*) encourages the infilling of urban areas, where infrastructure and services are available. The project complies with this policy, as it would replace an existing fire station within an established residential neighborhood and will enable the continuation of a necessary public service. The Montara Water and Sanitary District (MWSD) has confirmed that adequate water and sewer connections are available for the project.

c. Transportation Policies

Policy 12.21 (*Local Circulation Policies*) seeks to minimize through traffic in residential areas; provide access for emergency vehicles, and access for handicapped persons to public buildings.

The project proposes access to the new fire station via two (2) new driveways from Stetson Street. The driveways would provide access for emergency vehicles to the drive-through apparatus bays and entry and exit to onsite vehicle parking for staff and the public, including

nine (9) parking spaces with one (1) Americans with Disabilities Act (ADA) compliant parking space. Currently, the property is vehicle-accessible along the property's entire Stetson Street frontage due to very wide driveway apron. The use of two (2) designated driveways will improve vehicle and pedestrian safety along Stetson Street by restricting vehicle entry and exit points.

The project would not result in any negative impacts to fire vehicle traffic patterns as the number of employees and emergency vehicles are not proposed to change. The new Fire Station 44 would continue to serve the same geographic area and, given its purpose of replacing the existing station on the same parcel.

Temporary increases in truck traffic are expected during grading work. Grading activities will be limited to weekdays and truck routes will be subject to County Department of Public Works approval per Condition 6.

2. Conformance with the Local Coastal Program

Staff has reviewed and determined that the project complies with all of the applicable Local Coastal Program (LCP) Policies, including the following:

a. Locating and Planning New Development Component

Policy 1.19 (*Ensure Adequate Public Services and Infrastructure for New Development in Urban Areas*) requires that no permit for development in the urban area shall be approved unless it can be demonstrated that it would be served with adequate water supplies and wastewater treatment facilities. As stated in Section A.1.a above, the Montara Water and Sanitary District has confirmed adequate water supply and sewer treatment capacity to serve the project. For this reason, the project complies with LCP Policy 1.19.

b. Visual Resources Component

Policy 8.12(a)(1) (*General Regulations*) applies the Design Review Zoning District to urbanized areas of the Coastal Zone, which includes Moss Beach. The project is, therefore, subject to Design Review criteria established in the Community Design Manual. On November 23, 2024, staff identified compliance issues with the project design in an incomplete letter to the applicant. The applicant addressed staff concerns, primarily regarding the building bulkiness and light spillover at or near the property boundary. See further discussion in Section A.7 below.

Policy 8.13 (*Special Design Guidelines for Coastal Communities*) establishes design guidelines for Montara, Moss Beach, El Granada, and Miramar. The project complies with these guidelines as follows:

- (1) On-site grading is not extensive and only limited to standard construction activity.

The project proposes a total of 1,929 cu. yd. of grading (cut: 1,820 cu. yd; fill: 109 cu. yd.) to accommodate the proposed fire station and its associated improvements. Project grading involves expanding the flat area of the site and reducing the average grade by approximately 3 feet. Reduction of the grade will allow for a more consistent grade and for the building to sit lower on the site, reducing visual impacts to the area.

- (2) The proposed materials for the development such as cedar siding, have a natural appearance.
The project incorporated design elements, such as roof variation and natural colors, to ensure compliance with this criterion.

- (3) Project design uses gable roofs, including nonreflective, black composition shingle as the primary roof material.

The proposed new fire station would use various roof forms and dark shingles. For this reason, the project is found to be consistent with this guideline.

- (4) The project is designed to be compatible with development in the area.

As discussed in Section A.7 below, the replacement fire station is compatible with other development in the neighborhood. While the project faces competing priorities, such as building bulkiness and functionality for emergency services, the applicant has made design changes to minimize potential impact on neighborhood character.

3. Conformance with the Zoning Regulations

The subject parcel is in the R-1/S-17/DR/CD zoning district (One Family Residential District/Residential Density District 17/Design Review District/Coastal Development District). The project proposes a new fire station as a replacement to the existing Fire Station 44 (Originally approved under County File No. UP-1419).

As shown in the table below, the project complies with the development standards of the S-17 Zoning District, except those pertaining to floor area and front setback.

Development Standards	S-17 Zoning District	Proposed	Complies?
Building Site Area	5,000 sq. ft.	21,695 sq. ft.	Yes, no change
Maximum Building Site Coverage	35% (2,146.2 sq. ft.)	32.4% (7,025 sq. ft.)	Yes
Maximum Building Floor Area Ratio	6,200 sq. ft.	10,178 sq. ft.*	No, requires Variance
Minimum Front Setback	20 ft.	13 ft. 9 in	No, requires Variance
Minimum Rear Setback	20 ft.	Approx. 48 ft.	Yes
Minimum Right Side Setback	5 ft.	15 ft.	Yes
Minimum Left Side Setback	5 ft.	21 ft.	Yes
Minimum Combined Side Yard Setback	15 ft.	30 ft.	Yes
Maximum Building Height	28 ft.	28 ft. (as conditioned by Condition 3)	Yes

The applicant requests a Variance for exceptions to zoning development standards for building floor area and front setback, as discussed in Section A.6 below.

4. Use Permit Findings

The applicant is seeking a Use Permit, in accordance with Section 6500(b) of the County Zoning Regulations, to allow the location of a public service use in the R-1 (One-Family Residential) Zoning District.

In order to grant a Use Permit, the following finding must be made:

- (1) *The establishment, maintenance and/or conducting of the use will not, under the circumstances of the particular case, result in a significant adverse impact to coastal resources, or be detrimental to the public welfare or injurious to property or improvements in said neighborhood.*

The proposed fire station would replace the existing 3,100 sq. ft. fire station, located on the same parcel, with new facilities that are safe,

modern, and adequately sized to allow CFPD to continue serving the community. Operation and staffing for the newly constructed fire station are proposed to remain unchanged.

The proposed fire station involves new wall-mounted lighting fixtures and four (4) light poles near the property boundary. Condition 18 requires, at the time of building permit application, the submittal of a lighting plan in compliance with the revised lighting plan showing foot candle measurements to each property line and for the further reduction, to the extent feasible, of spillover lighting to residential properties and Sierra Street.

The operation of the new fire station, including fire alarms and emergency vehicle sirens, would not result in an increase noise level to the area as the project maintains the existing use of the property.

The proposed fire station has been designed to fit into the irregular-shape parcel and, to the extent feasible, complements the surrounding development. The project's design, orientation, landscaping, and location would aid in buffering impacts to the surrounding community and adjacent residences. Additionally, the project is not expected to result in an increase in traffic as the capacity and staffing of the fire station are intended to remain the same.

Based on the foregoing, the project would not result in a significant adverse impact to coastal resources or be detrimental to the public welfare or injurious to property or improvements in said neighborhood.

5. Variance Findings

The purpose of a variance is to allow, under special circumstances, development to vary from the requirements of the Zoning Regulations when strict enforcement would make it difficult to develop a parcel, cause unnecessary hardship to the landowner, or result in inconsistencies with the general purpose of the Zoning Regulations.

The applicant is seeking a Variance for exceptions to the front setback and maximum building floor area, as set forth by the zoning district, in order to build a new, replacement fire station that meets the modernization needs of fire staff and emergency fire protection services.

It should be noted that, in response to staff and community comments related to the building height exceedance, the applicant has withdrawn the variance request for height exceedance and redesigned the fire station to reduce the building height from 32 feet 3 inches to 28 feet. The building height reduction would significantly reduce the project's impact on views from the adjacent properties.

In order to approve a variance, the following findings shall be made:

- (1) *The parcel's location, size, shape, topography, and/or other physical conditions vary substantially from those of other parcels in the same zoning district or vicinity.*

The project does not comply with the minimum required setback (20 feet) and maximum building floor area (6,200 sq. ft.) of the zoning district. Although the parcel is substantially larger than other parcels in the neighborhood, per CFPD staff, a variance is needed due to the following reasons:

Front Setback Variance

The applicant proposes 13 feet 9-inch setback for the front of the building.

Given the lot size, topography, and irregular shape of the project parcel, the required front yard setback presents a challenge to ensuring adequate functionality. To provide an adequate circulation for fire trucks through the apparatus bays and adequate internal circulation for the building, the front setback reduction is necessary, per CFPD staff.

Further, the proposed building footprint is necessary to ensure full functionality of the proposed fire station, including providing a modern working environment and accommodating modern equipment. Therefore, the CFPD is unable to reduce the building footprint to comply with the required front setback.

Considering these factors, a Variance from the minimum front setback requirement is needed to allow for the construction of a new fire station that effectively serves the community's fire protection needs. A reduced front yard setback would ensure that the fire station remains fully functional and capable of responding promptly to emergencies, thus safeguarding the welfare of residents and properties within the CFPD's service area.

Floor Area Variance

The R-1/S-17 Zoning Regulations cap the maximum floor area at 6,200 sq. ft., primarily applying to single-family residences; however, the fire station, being unique in its function, necessitates an exception to this limit to ensure adequate functionality for current and future community and staff needs. The fire station's role in maintaining community safety and responding efficiently to emergencies justifies the need for additional space to accommodate essential equipment,

personnel, and operational facilities. This expansion is crucial to address the growing demands of the community, enhance operational efficiency, and maintain rapid response times. For these reasons, the requested maximum floor area variance is deemed appropriate and necessary.

- (2) *The variance does not grant the landowner a special privilege which is inconsistent with the restrictions placed on other parcels in the same zoning district or vicinity.*

Due to the distinctive nature of this public use, the Variance is not deemed to confer a special privilege. Unlike residential or commercial developments, a fire station serves a unique function that contributes to the public safety of the community. Special circumstances inherent to fire station operations necessitate deviations from standard zoning development standards and restrictions.

- (3) *Without the variance, the landowner would be denied the rights and privileges that are enjoyed by other landowners in the same zoning district or vicinity.*

The applicant has incorporated features to minimize project impacts to the surrounding community. Denial of the variance would place an unnecessary hardship, including cost, on CFPD and could impact the functionality and impede the emergency response speed of the fire station, potentially leading to emergency service delays for the community.

- (4) *The variance authorizes only uses or activities which are permitted by the Zoning District.*

Chapter 6 (One-Family Residential District) and Chapter 24 (Use Permit) of the County Zoning Regulations allows fire station and public service uses to be located in the zoning district, subject to the issuance of a Use Permit, for which the CFPD is seeking as part of the subject application.

- (5) *The variance is consistent with the objectives of the General Plan, the Local Coastal Program (LCP) and the Zoning Regulations.*

See staff's discussion in Sections A.1. through A.5. for project compliance with the applicable policies and standards of the General Plan, LCP, and Zoning Regulations.

6. Design Review

The project site is located in a Design Review District; therefore, staff has reviewed and determined that the proposed fire station development complies with the applicable design standards contained in Section 6565.17 of the Zoning Regulations.

- (1) *Proposed structures are designed and situated so as to retain and blend with the natural vegetation and landforms of the site; a smooth transition is maintained between development and adjacent open areas through the use of natural landscaping and plant materials which are native or appropriate to the area; paved areas should be integrated into the site, relate to their structure, and be landscaped to reduce visual impacts from residential areas and roadways.*

The project proposes to construct the proposed fire station in a relatively flat area on the parcel and to expand the flat usable area to accommodate the necessary features of the station. Retaining walls are proposed in rear and side yards to ensure slope stability. The project site contains minimal vegetation due to the previous site disturbance and operation of the existing fire station. Although the fire station is larger and taller than other structures in the neighborhood, topography, existing development, and proposed landscaping, as screening elements, would reduce visual impacts on adjacent residential properties and from viewing locations along Stetson and Sierra Streets and the Cabrillo Highway.

- (2) *Grading should blend with adjacent landforms and not create drainage or erosion problems; trees and vegetative land cover are removed only where necessary.*

Regarding site grading, see discussion above. The project has been reviewed and conditioned by the County's Drainage Section. Additional reviews will be conducted to ensure compliance with the County Drainage Manual at the time of the building permit application. No tree removal is proposed as part of the project.

- (3) *Natural drainage systems should not be altered so as to affect their character and cause problems of drainage, erosion or flooding; structures should be located outside of flood zones, drainage channels, and other areas subject to inundation.*

The project would not alter any natural drainage systems. The project site is located with Flood Zone X (area of minimal flood). As noted above, the County's Drainage Section will ensure substantial compliance with the County Drainage Manual at the time of the building permit application.

- (4) *Views are protected by the height and location of structures; public views to and along the shoreline from public roads and other public lands are protected; overhead utility lines are placed underground where appropriate to reduce the visual impact on open and scenic areas.*

The building has been designed and oriented to minimize public view impacts to adjoining streets and residential properties, to the extent feasible, while prioritizing the needs for emergency services and functionality of the new fire station. The project is screened from the Cabrillo Highway by distance, topography, existing development, and vegetation. The project would result in minimal impact on the ocean views of structures along Sierra Street as those properties are currently vacant and have an approximately 11-foot higher natural grade elevations. As proposed and conditioned, utility lines would be placed underground. The applicant has agreed to reduce the building height to the 28 feet maximum, which would significantly reduce the project's impact on views from adjacent properties.

- (5) *Varying architectural styles are made compatible through the use of similar materials and colors which blend with the natural setting and surrounding neighborhood; the design of the structure is appropriate to the use of the property and is in harmony with the shape, size and scale of adjacent building in the community.*

The proposed fire station is designed to blend into the surrounding residential development and uses various roof forms, exterior materials (including siding), and earth-toned colors. The project would blend into the existing neighborhood and minimize impacts to existing views.

- (6) *Signs should be compatible with the architectural style of the structure they identify and harmonize with their surroundings.*

The proposed development includes one (1) wall mounted identification sign to the left of the apparatus bay doors. The signage consists of the name and logo of the Coastside Fire Protection District. The identification sign is proportional to the building and do not detract from the architectural style of the building or developed character of the area.

7. Conformance with the Grading Ordinance

The project proposes a total of 1,929 c.y. of grading (cut: 1,820 c.y.; fill: 109 c.y.) to accommodate the proposed fire station and associated improvements. Staff has reviewed and determined that the following

findings necessary to approve the project, pursuant to Section 9290 of the San Mateo County Ordinance Code, should be made:

- a. *The granting of the permit will not have a significant adverse effect on the environment.*

The proposed grading is necessary to implement the project. The project site is previously graded and contains a steep slope from Sierra Street in the rear portion of the site and from side property lines. The proposed grading is necessary for the project to provide sufficient space for construction, parking, and circulation. Additionally, the site is currently disturbed and contains no sensitive habitats.

- b. *The project conforms to the criteria of Chapter 8, Division VII, of the San Mateo County Ordinance Code, including the standards referenced in Section 9296.*

The project, as proposed and conditioned, conforms to standards in the Grading Ordinance, including those relative to erosion and sediment control plan, dust control plan, fire safety, and the timing of grading activity. The project plans have been reviewed and recommended for approval by both the Geotechnical Section and the Department of Public Works. Conditions of approval have been included in Attachment A to ensure compliance with the County's Grading Ordinance.

- c. *The project is consistent with the General Plan.*

The project has been reviewed against the applicable policies of the San Mateo County General Plan and found to be consistent. See Section A.1 of this report for a detailed discussion regarding the project's compliance with applicable General Plan Policies.

8. Conformance with the Half Moon Bay Airport Land Use Compatibility Plan

Upon review of the provisions of the Half Moon Bay ALUCP for the Environs of Half Moon Bay Airport, as adopted by the City/County Association of Governments (C/CAG) on October 9, 2014, staff has determined that the project's site location complies with the safety, noise, and height limit criteria for airport compatibility. The project site is located in the Half Moon Bay Airport Zone 7, Airport Influence Area (AIA), where the accident risk level is considered low. The AIA does not prohibit public service uses, such as a fire station. The proposed project complies with all AIA development conditions in the Safety Criteria Matrix of the ALUCP, including but not limited to the flight hazard prevention measures, as the proposed two-story fire station would not penetrate the established airspace threshold. The

project site is outside of the defined aircraft noise exposure contours and, therefore, would not be exposed to high levels of aircraft noise.

B. COMMENTS FROM MIDCOAST COMMUNITY COUNCIL (MCC)

In a letter dated January 24, 2024, the MCC expressed concerns primarily related to lighting, ventilation, and fuel storage. Specifically, the MCC is concerned with fumes and noise that may be generated by the engines and equipment. The applicant has addressed concerns regarding ventilation and fuel storage, which will undergo further review during the building stage.

As for lighting, MCC was concerned with spillover lighting and the project's impact on the "dark-sky" of the area. The project proposes new wall-mounted lighting fixtures and four (4) light poles near the property boundary. According to the lighting plan, spillover light would be present at the property boundary, potentially causing light pollution to adjacent properties. Planning staff suggested eliminating the light poles and recommended wall-mounted lights or portable lights to minimize spillover light at or across the property boundary.

As discussed in Section A.1.a above, the applicant acknowledged the feedback received from staff and the Midcoast Community Council regarding spillover and night-sky impacts. In response to the concerns, the applicant revised the lighting plan to incorporate fully dimmable lighting, with the ability to operate on a timer to prevent unwanted illumination during dark hours. The project also employs a dual head approach where warm lighting colors will be utilized under normal circumstances, with the option to activate cooler light colors only in emergencies. Additionally, Condition 18 requires compliance with the revised Lighting Plan at the time of building permit submittal, as well provision of foot candle measurements at every property line.

C. COMMENTS FROM MEMBERS OF THE PUBLIC

A community meeting (Item 4a. On the Midcoast Community Council's agenda) was held for the subject application as well as the associated temporary fire station project (County File No. PLN2024-00033) on May 22, 2024. Members of the public expressed concerns regarding public health (noise and hazardous fumes), building floor area, exterior colors, light spill, and site suitability.

Lighting

As discussed in Section B above, the applicant revised the original lighting plan to reduce light spillover at and near the property boundary. This revision includes replacing the north light pole with a lower light bollard and proposing dimmable, dual-head lights to avoid cool lights being turned on in non-emergency situations. Despite these changes, members of the public remain concerned about potential light spillover at or across the property boundaries.

In response to this comment, the applicant has agreed to further improve the lighting plan. The applicant stated that they attempt to blend the lighting in with existing conditions and avoid any harsh light that would disturb neighbors and wildlife while still meeting at least the minimum lighting requirements needed for the emergency operations at the site. The applicant has further revised the lighting plan to include lighting fixtures mounted on the retaining walls, which will prevent light from spilling over into neighboring houses. However, pole-mounted lights will remain at the back of the station, which will be activated only during emergencies and controlled by a key system.

Exterior Color

The latest design of the fire station includes a light exterior color on the second floor. A speaker expressed concerns that this color is inconsistent with the character of the neighborhood and is reflective. In response to this concern, the applicant has updated the color board as shown in Attachment E.

Public Health

A speaker was concerned about hazardous fumes or substances that may be caused by hazmat equipment and vehicle engines. The applicant responded by stating that the new engine for this station uses a diesel exhaust fluid contamination system, known as clean diesel, which produces lower emissions.

Site Suitability

A speaker suggested that the proposed fire station be relocated to the vacant site that is reserved for the temporary fire station. The speaker emphasized that the proposed project site is surrounded by residential developments which are vulnerable to potential noise, light, and traffic from the proposed fire station. In this regard, the MCC requested that the applicant provide an alternative site analysis that identifies the most suitable site and justifies the site selection.

In response, the applicant provided a justification for the selected site. See Attachment F for the Letter of Justification.

Building Floor Area

The proposed fire station would be approx. 7,000 sq. ft. larger than the existing fire station. Members of the public questioned the necessity for this substantial floor area increase.

The applicant has stated that the proposed additional floor area is necessary to accommodate additional personnel during emergency events, such as natural disasters. In addition, the additional floor area is needed to house modern equipment and amenities. This includes facilities such as a fitness room and a

training room, which are essential for maintaining the readiness of the firefighters. Overall, the proposed expansion intends to enhance the functionality and preparedness of the facility, ensuring it can meet the demands of both routine operations and emergency situations.

D. COMMENTS FROM CALIFORNIA COASTAL COMMISSION (CCC)

In an email, dated November 27, 2023, the CCC staff identified concerns related to the zoning compliance, as well as impervious surface and drainage. The applicant has agreed to reduce the building height to comply with zoning height limits by redesigning the upper portion of the proposed fire station. As discussed in Section A.1 through A.8, the granting of exceptions to maximum building floor area and minimum front setback is necessary to ensure the functionality and operational safety of the fire station. Regarding drainage and impervious surface, County Zoning Regulations Section 6300.2 limits the amount of parcel area covered by impervious structures less than 18 inches in height to 10% parcel size. The section allows deviation from the maximum impervious surface ratio if off-site project drainage (i.e., runoff) will not exceed that amount equivalent to 10% (parcel size) which could be achieved by directing runoff to on-site porous areas or through the use of detention basins. Per the County Drainage Manual, the project's post-development run-off will not exceed pre-project run-off levels. The project also incorporates a biotreatment basin at the front of the property. The project has been reviewed and conditioned by the County's Drainage Section. The Section staff would further review the project at the building stage for compliance with State stormwater treatment requirements and local drainage requirements.

E. ENVIRONMENTAL REVIEW

This project is exempt from environmental review pursuant to the California Environmental Quality Act (CEQA) Guidelines Section 15302, Class 2, relating to the replacement or reconstruction of existing structures where the new structure will be located on the same site as the structure replaced and will have substantially the same purpose and capacity as the structure replaced. According to the applicant, the proposed fire station, despite its increase in floor area, will not increase its capacity in terms of number of employee and operational scope. For these reasons, the project is exempt from the California Environmental Quality Act.

F. REVIEWING AGENCIES

San Mateo County Building Inspection Section
San Mateo County Department of Public Works
San Mateo County Geotechnical Section
Coastside Fire Protection District
Montara Water and Sanitary District
California Coastal Commission

Midcoast Community Council

ATTACHMENTS

- A. Recommended Findings and Conditions of Approval
- B. Vicinity/Location map
- C. Project Plans
- D. Photos of The Existing Fire Station 44
Add exhibits referenced above
- E. Updated Color and Material Board
- F. Letter of Justification

County of San Mateo
Planning and Building Department

RECOMMENDED FINDINGS AND CONDITIONS OF APPROVAL

Permit or Project File Number: PLN2023-00311

Hearing Date: June 26, 2024

Prepared By: Glen Jia, Project Planner

For Adoption By: Planning Commission

RECOMMENDED FINDINGS

For the Environmental Review, Find:

1. That the project is exempt from environmental review pursuant to the California Environmental Quality Act (CEQA) Guidelines Section 15302, Class 2, relating to the replacement or reconstruction of existing structures where the new structure will be located on the same site as the structure replaced and will have substantially the same purpose and capacity as the structure replaced. The proposed fire station, despite its increase in floor area, will not increase its capacity in terms of employee numbers and operational scope. For these reasons, the project is exempt from the California Environmental Quality Act.

For the Coastal Development Permit, Find:

2. That the project, as described and conditioned, conforms to the plans, policies, requirements and standards of the San Mateo County Local Coastal Program (LCP), specifically in regard to Policy 1.19 (*Ensure Adequate Public Services and Infrastructure for New Development in Urban Areas*), Policy 8.12(a)(1) (*General Regulations*), Policy 8.13 (*Special Design Guidelines for Coastal Communities*), and Policy 8.13 (*Special Design Guidelines for Coastal Communities*). The project does not pose any adverse significant impacts on coastal resources, sensitive habitats, or visual resources in the area.
3. That the project is not subject to the public access and public recreation policies of Chapter 3 of the Coastal Act of 1976 (commencing with Section 30200 of the Public Resources Code) since the project is not located between the nearest public road and the sea, or the shoreline of Pescadero Marsh.
4. That the project conforms to specific findings required by policies of the San Mateo County LCP with regard to Appearance of New Development, Visual Resources, Infilling, and Urban Area Design Concept, as discussed in the staff report.

For the Use Permit, Find:

5. That the establishment, maintenance and/or conducting of the use will not, under the circumstances of the particular case, result in a significant adverse impact to coastal resources, or be detrimental to the public welfare or injurious to property or improvements in said neighborhood as the new fire station will allow the Coastside Fire Protection District to modernize its facilities to meet the emergency service needs of the community; the proposed fire station has been designed to minimize public view impacts and blend into the neighborhood character and natural environment through architectural style and proportion. Further, the new fire station will not result in any changes to operation, staffing, or emergency vehicle trips.

For the Variance, Find:

6. That the proposed use and the parcel's location, size, shape, topography, and/or other physical conditions vary from those of other parcels in the same zoning district or vicinity due to the unique use as a fire station. A variance is necessary for the applicant to ensure full functionality of the fire station.
7. That without the variance, the landowner would be denied the rights and privileges that are enjoyed by other landowners in the same zoning district or vicinity. Granting the variance is essential as the fire station would serve a unique, essential public use and would accommodate modern emergency apparatus despite the parcel's topography, shape, and size, which make full compliance with zoning standards challenging. Denial of the variance would hinder the fire station's functionality and emergency response speed, potentially delaying critical services for the community.
8. That the variance does not grant the landowner a special privilege which is inconsistent with the restrictions placed on other parcels in the same zoning district or vicinity as the other parcels in the R-1 Zoning District are subject to the same development standards and may seek variances if physical site constraints are demonstrated. The proposed building footprint is necessary to ensure full functionality of the fire station, including providing a modern working environment and accommodating fire trucks and equipment. Therefore, the Coastside Fire Protection District is unable to reduce the building footprint to comply with the required front setback.
9. That the variance authorizes only uses or activities which are permitted by the zoning district as the County Zoning Regulations allows public service uses in any zoning district subject to the issuance of a use permit, for which the applicant is seeking as part of the subject project application.

- 10. That the variance is consistent with the objectives of the General Plan, the LCP and the Zoning Regulations as discussed in Sections A.1. through A.8. of the staff report.

For the Design Review, Find:

- 11. That the project complies with the applicable design standards contained in Section 6565.17 of the Zoning Regulations as the proposed fire station is designed to blend into the surrounding residential development and uses various roof forms, siding, and earth-toned colors; the building will be set into the excavated project site so as to minimize visual impacts from uphill views towards the ocean; the development includes on-site drainage facilities to capture and treat post-construction runoff; erosion control measures will be implemented to minimize construction-related erosion and sediment from the project site; denuded areas will be replaced with appropriate landscaping that consists of plant species that are native and/or acclimated to the local area so as to not alter or impact the sensitive area; and the proposed building identification signage is proportional to the building and does not detract from the architectural style of the building or developed character of the area.

For the Grading Permit, Find:

- 12. That the granting of the permit will not have a significant adverse effect on the environment.
- 13. That the project conforms to the criteria of Chapter 8, Division VII, San Mateo County Ordinance Code, including the standards referenced in Section 9296, as the project, as conditioned, conforms to the standards in the County Grading Regulations, including those relative to erosion and sediment control, dust control, fire safety, and timing of grading activity. Furthermore, the project has been reviewed and approved by the County’s Department of Public Works and the County’s Geotechnical Engineer.
- 14. That the project is consistent with the General Plan as the project conforms to all applicable General Plan policies, including Vegetative, Water, Fish and Wildlife Resources; Soil Resources; Visual Quality policies.

RECOMMENDED CONDITIONS OF APPROVAL

Current Planning Section

- 1. The project shall be constructed in compliance with the plans approved by the Planning Commission on June 26, 2024. Any changes or revisions to the approved plans are subject to review and approval by the Director of Planning and Building. Minor adjustments to project design may be approved by the Director if they are consistent with the intent of and are in substantial conformance with this approval.

2. The Coastal Development Permit, Design Review Permit, Variance, Use Permit, and Grading Permit shall be valid for five (5) years from the date of final approval, in which time a building permit shall be issued, and a completed inspection (to the satisfaction of the building inspector) shall have occurred within 180 days of its issuance. The design review approval may be extended by one time for a one (1) year increment with submittal of an application for permit extension and payment of applicable extension fees 60 days prior to the expiration date.
3. The applicant shall provide “finished floor elevation verification” to certify that the structure is actually constructed at the maximum height of the zoning district of 28 feet. The applicant shall have a licensed land surveyor or engineer establish a baseline elevation datum point in the vicinity of the construction site.
 - a. The applicant shall maintain the datum point so that it would not be disturbed by the proposed construction activities until final approval of the building permit.
 - b. This datum point and its elevation shall be shown on the submitted site plan. This datum point shall be used during construction to verify the elevation of the finished floors relative to the existing natural or to the grade of the site (finished grade).
 - c. Prior to Planning approval of the building permit application, the applicant shall also have the licensed land surveyor or engineer indicate on the construction plans: (1) the natural grade elevations at the significant corners (at least four) of the footprint of the proposed structure on the submitted site plan, and (2) the elevations of proposed finished grades.
 - d. In addition, (1) the natural grade elevations at the significant corners of the proposed structure, (2) the finished floor elevations, (3) the topmost elevation of the roof, and (4) the garage slab elevation shall be shown on the plan, elevations, and cross-section (if one is provided).
 - e. Once the building is under construction, prior to the below floor framing inspection or the pouring of the concrete slab (as the case may be) for the lowest floor(s), the applicant shall provide to the Building Inspection Section a letter from the licensed land surveyor or engineer certifying that the lowest floor height, as constructed, is equal to the elevation specified for that floor in the approved plans. Similarly, certifications on the garage slab and the topmost elevation of the roof are required.
 - f. If the actual floor height, garage slab, or roof height, as constructed, is different than the elevation specified in the plans, then the applicant shall cease all construction and no additional inspections shall be approved until a revised set of plans is submitted to and subsequently approved by both the Building Official and the Director of Planning and Building.

4. The applicant shall submit all approved exterior color and material specifications as part of the building permit submittal. Color and materials verification by the Current Planning Section shall occur prior to final building inspection.
5. At the building permit application stage, the project shall demonstrate compliance with the Water Efficient Landscape Ordinance (WELo) and provide required forms. The Water Efficient Landscape Ordinance applies to new landscape projects equal to or greater than 500 square feet. A prescriptive checklist is available as a compliance option for projects under 2,500 sq. ft. WELo also applies to rehabilitated landscape projects equal to or greater than 2,500 square feet. The following restrictions apply to projects using the prescriptive checklist:
 - a. Compost: Project shall incorporate compost at a rate of at least four (4) cubic yards per 1,000 sq. ft. to a depth of 6 inches into landscape area (unless contra-indicated by a soil test).
 - b. Plant Water Use (Residential): Install climate adapted plants that require occasional, little or no summer water (average WUCOLS plant factor 0.3) for 75% of the plant area excluding edibles and areas using recycled water.
 - c. Mulch: A minimum 3-inch layer of mulch should be applied on all exposed soil surfaces of planting areas, except in areas of turf or creeping or rooting groundcovers.
 - d. Turf: Total turf area shall not exceed 25% of the landscape area. Turf is not allowed in non-residential projects. Turf (if utilized) is limited to slopes not exceeding 25% and is not used in parkways less than 10 feet in width. Turf, if utilized in parkways is irrigated by sub-surface irrigation or other technology that prevents overspray or runoff.
 - e. Irrigation System: The property shall certify that Irrigation controllers use evapotranspiration or soil moisture data and utilize a rain sensor; irrigation controller programming data would not be lost due to an interruption in the primary power source; and areas less than 10 feet in any direction utilize sub-surface irrigation or other technology that prevents overspray or runoff.
6. No grading activities shall commence until the applicant has been issued a Grading Permit "Hard Card" by the Planning Department. Prior to the issuance of a Grading Permit "Hard Card," the applicant shall submit a truck route map to the Project Planner, subject to review by the Department of Public Works.
7. No grading shall be allowed during the wet weather season (October 1 through April 30) to avoid potential soil erosion, unless the applicant applies for an Exception to the Winter Grading Moratorium and the Community Development Director grants the exception. Exceptions will only be granted if dry weather is forecasted during scheduled grading operations, and the erosion control plan includes adequate winterization measures (amongst other determining factors).

8. The site is considered a Construction Stormwater Regulated Site (SWRS). Any grading activities conducted during the wet weather season (October 1 to April 30) will require monthly erosion and sediment control inspections in compliance with the National Pollutant Discharge Elimination System Municipal Regional Permit Section C.6 (Construction Site Control) and Planning and Building Department's Enforcement Response Plan.
9. An Erosion Control and Tree Protection Pre-Site Inspection shall be conducted prior to the issuance of a grading permit "hard card" and building permit to ensure the approved erosion control and tree protection measures are installed adequately prior to the start of ground disturbing activities.
10. The provision of the San Mateo County Grading Ordinance shall govern all grading on the project site. Per San Mateo County Ordinance Code Section 9296.5, all equipment used in grading operations shall meet spark arrester and firefighting tool requirements, as specified in the California Public Resources Code.
11. The engineer who prepared the final approved grading and drainage plans shall be responsible for the inspection and certification of the grading as required by Section 9297.2 of the Grading Ordinance. The engineer's responsibilities shall include those relating to non-compliance detailed in Section 9297.4 of the Grading Ordinance.
12. In order to receive final sign-off on the Grading Permit "Hard Card," the applicant shall ensure performance of the following activities within thirty (30) days of the completion of grading at the project site:
 - a. The engineer shall submit written certification, that all grading has been completed in conformance with the approved plans, conditions of approval/mitigation measures, and the Grading Regulations, to the Department of Public Works and the Planning and Building Department's Geotechnical Engineer.
 - b. The geotechnical consultant shall observe and approve all applicable work during construction and sign Section II of the Geotechnical Consultant Approval form, for submittal to the Planning and Building Department's Geotechnical Engineer and the Current Planning Section.
 - c. Please include the Geotechnical File Number, 10B-920, in all correspondence with the Geotechnical Section of the Planning and Building Department.

13. Erosion and sediment control during the course of grading work shall be according to the plan prepared and signed by the engineer of record and approved by the Department of Public Works and the Current Planning Section. Revisions to the approved erosion and sediment control plan shall be prepared and signed by the engineer and reviewed and approved by the Department of Public Works and the Current Planning Section.
14. It shall be the responsibility of the engineer of record to regularly inspect the erosion control measures for the duration of all grading activities, especially after major storm events, and determine that they are functioning as designed and that proper maintenance is being performed. Deficiencies shall be immediately corrected, as determined by and implemented under the observation of the engineer of record.
15. Noise sources associated with demolition, construction, repair, remodeling, or grading of any real property shall be limited to the hours from 7:00 a.m. to 6:00 p.m. weekdays and 9:00 a.m. to 5:00 p.m. Saturdays. Said activities are prohibited on Sundays, Thanksgiving, and Christmas (San Mateo County Ordinance Code Section 4.88.360).
16. Prior to the commencement of grading or construction at the project site, an information sign shall be posted at the entrance to the construction site that identifies the permitted construction hours and provides a telephone number to call and receive information about the construction project or to report complaints regarding excessive noise levels.
17. All new electric lines shall be installed underground from the nearest existing utility pole.
18. To reduce spillover lighting and night-sky impacts, the applicant shall comply with the revised Lighting Plan at the time of building permit submittal, including the project elements below, and provide foot candle measurements extending to every property line. The foot candle measurements shall be consistent with the revised Lighting Plan. Any further reduction of lighting spillover at or near the property lines is highly encouraged to the extent feasible. Any changes to the Lighting Plan are subject to the review of the Planning and Director of Planning and Building.
 - a. Fully dimmable lighting, with the ability to operate on a timer to prevent unwanted illumination during dark hours.
 - b. Dual head approach where warm lighting colors will be utilized under normal circumstances, with the option to activate cooler light colors only in emergencies.

- c. Replacement of a light to the left of the north response drive with a light bollard and use of a high berm to prevent light spill onto neighboring properties.

Department of Public Works

19. Prior to the issuance of the building permit, the applicant shall submit a driveway "Plan and Profile," to the Department of Public Works, showing the driveway access to the parcel (garage slab) complying with County Standards for driveway slopes (not to exceed 20%) and to County Standards for driveways (at the property line) being the same elevation as the center of the access roadway. When appropriate, as determined by the Department of Public Works, this plan and profile shall be prepared from elevations and alignment shown on the roadway improvement plans. The driveway plan shall also include and show specific provisions and details for both the existing and the proposed drainage patterns and drainage facilities.
20. No proposed construction work within the County right-of-way shall begin until County requirements for the issuance of an encroachment permit, including review of the plans, have been met and an encroachment permit issued. Applicant shall contact a Department of Public Works Inspector 48 hours prior to commencing work in the right-of-way.
21. Prior to the issuance of the building permit, the applicant will be required to provide payment of "roadway mitigation fees" based on the square footage (assessable space) of the proposed building per Ordinance No.3277.

County Geotechnical Section

22. The Project Geotechnical Consultant (Geocon) has provided recommendations that are in conformance with the California Building Code 2022 and general standard of practice. This report and plan shall pass provided the following conditions are met. 1. The "Shallow Foundations" describes that the footings only need to be embedded 18 inches below the existing grade provided they are founded on top of competent material. As written, this is insufficient for passive lateral support. We suggest that the geotechnical consultant update the language in the "Shallow Foundations" section of the report to require that the footings be embedded 18 inches in competent material.
23. Geotechnical report required at building permit stage. Geotechnical Consultant of Record shall review and approve the grading plans, drainage plan(s) related to the geotechnical aspects, and foundation plans at the minimum. Plans review letter shall be submitted to County for review and approval.
24. The Geotechnical Consultant of Record shall propose site geotechnical inspections specifications in the geotechnical report. The specifications shall be in compliance with CBC 2022 as a minimum.

County Drainage Section

25. The project is a Regulated Project and shall demonstrate compliance with Provision C3 of the State Municipal Regional Permit at the time of building permit application.
26. CONDITIONS FOR BIO TREATMENT:
 - a. Biotreatment measures (including bioretention areas, flow-through planters and non-proprietary tree well filters) shall be sized to treat runoff from 100% of the applicable drainage area (all impervious areas and applicable landscaped areas) using flow or volume based sizing criteria as described in the Provision C.3.d of the MRP, or using the simplified sizing method (4% rule of thumb), described in the **C.3 Regulated Projects Guide**: <https://www.smcgov.org/media/146080/download?attachment> and based on the flow-based sizing criteria in Provision C.3.d.i.(2)(c).
 - b. Plant species used within the biotreatment measure area shall be consistent with Appendix A of the C.3 Regulated Projects Guide.
 - c. Biotreatment soil mix for biotreatment measures shall have a minimum percolation rate of 5 inches per hour and a maximum percolation rate of 10 inches per hour and shall be in conformance with Attachment L of the MRP, which is included in Appendix K of the C.3 Regulated Projects Guide.
 - d. Design of biotreatment measures shall be consistent with technical guidance for the applicable type of biotreatment measure provided in the C.3 Regulated Projects Guide.
27. CONDITIONS FOR INFILTRATION TRENCH
 - a. In-situ infiltration rate shall be determined or confirmed by means of percolation testing for all infiltration treatment measures and devices.
 - b. Infiltration devices shall not be used where confirmed seasonal high groundwater is less than 10 feet from the bottom of infiltration measure or device.
 - c. Infiltration treatment measures or devices shall be designed in accordance with the infiltration guidance in Appendix E of the C.3 Regulated Projects Guide.
 - d. All infiltration devices shall be located and designed to ensure no damage will occur to surrounding improvements from underground water.
 - e. Soil media within the bio-infiltration measure shall consist of 18 inches of biotreatment soil consistent with Attachment L of the MRP.

- f. Other parameters of final design shall be consistent with the design guidelines presented in the latest version of the C.3 Regulated Projects Guide.

28. CONDITIONS FOR OPERATION AND MAINTENANCE

- a. Prior to the final of the building permit for the project, the property owner shall coordinate with the Project Planner to enter into an Operation and Maintenance Agreement (O&M Agreement) with the County (executed by the Director of Planning and Building) to ensure long-term maintenance and servicing by the property owner of stormwater site design and treatment control [and/or HM] measures according the approved Maintenance Plan(s), for the life of the project. The O&M Agreement shall provide County access to the property for inspection. The Maintenance Agreement(s) shall be recorded for the property and/or made part of the CC&Rs.
- b. Property owner shall be responsible for conducting all servicing and maintenance as described and required by the treatment measure(s) [and HM measure] Maintenance Plan(s). Maintenance of all site design and treatment control [and/or HM] measures shall be the owner's responsibility.
- c. The property owner is responsible for submitting an Annual Report accompanied by a review fee to the County by December 31 of each year, as required by the O&M Agreement. The property owner is also responsible for the payment of an inspection fee for County inspections of the stormwater facility, conducted as required by the NPDES Municipal Regional Permit.
- d. Approved Maintenance Plan(s) shall be kept on-site and made readily available to maintenance crews. Maintenance Plan(s) shall be strictly adhered to.
- e. Site access shall be granted to representatives of the County, the San Mateo County Mosquito and Vector Control District, and the Water Board, at any time, for the sole purpose of performing operation and maintenance inspections of the installed stormwater treatment systems [and HM controls]. A statement to that effect shall be made a part of the Maintenance Agreement and/or CC&Rs recorded for the property.
- f. Property owner shall be required to pay for all County inspections of installed stormwater treatment systems as required by the Regional Water Quality Control Board or the County.

Montara Water and Sanitary District (MWSD)

29. Submit Existing Service Application and pay for the initial application fees based on the remodeling type determined by MWSD. Applicant shall follow the procedures specified in the Existing Service Application Packet.
30. Video CCTV lower lateral and submit to MWSD for review. Any defects or pipe that is not to current MWSD code shall be replaced.
31. Current code construction details and additional backflow protection requirements shall apply. Upgrade to 6-inch lateral is recommended. Fifteen (15) feet easement width for all MWSD mains is required. The condition of the existing water meter(s), backflow preventer and water lateral connection shall be inspected by MWSD to determine if they are in good working condition; MWSD may require repair or replacement of the existing water meter(s), backflow preventer and water lateral connection. Water meter upgrade may be required.
32. If connection to the MWSD fire protection system is required: Certified Fire Protection Contractor must certify adequate fire flow calculations. Connection fee for fire protection system is required. Connection charge must be paid prior to issuance of Private Fire Protection permit. Applicants must first apply directly to MWSD for permits and not their contractor.

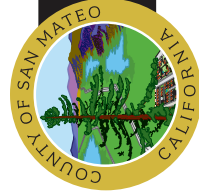

COUNTY OF SAN MATEO - PLANNING AND BUILDING DEPARTMENT

ATTACHMENT B

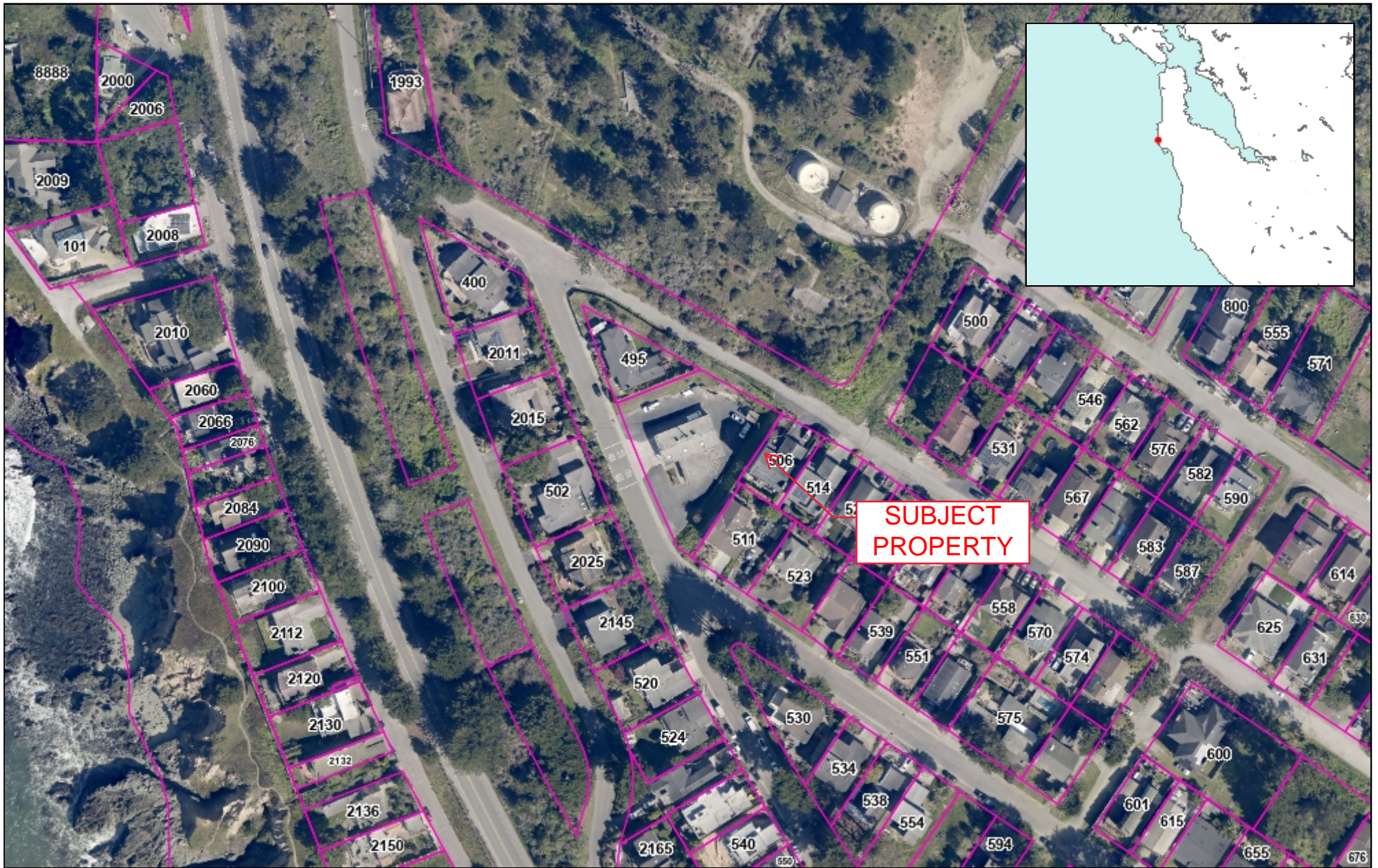

**SUBJECT
PROPERTY**

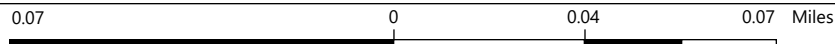

WGS_1984_Web_Mercator_Auxiliary_Sphere
© Latitude Geographics Group Ltd.

1:2,257

This map is a user generated static output from an Internet mapping site and is for reference only. Data layers that appear on this map may or may not be accurate, current, or otherwise reliable.

THIS MAP IS NOT TO BE USED FOR NAVIGATION



COUNTY OF SAN MATEO - PLANNING AND BUILDING DEPARTMENT

ATTACHMENT C

COASTSIDE FIRE PROTECTION DISTRICT



FIRE STATION #44

5/22/2024



ARCHITECT
SAN LUIS OBISPO
1327 ARCHER STREET, SUITE 110
SAN LUIS OBISPO, CA 93401
805-329-3076

Not for permitting or construction

CODES & STANDARDS

PARTIAL LIST OF APPLICABLE CODES	
2022 California Administrative Code (CAC)	(Part 1, Title 24, CCR)
2022 California Building Code (CBC)	(Part 2, Title 24, CCR)
(2021 International Building Code Volumes 1 & 2 with 2022 California Amendments)	(Part 2, Title 24, CCR)
2022 California Electrical Code (CEC)	(Part 3, Title 24, CCR)
(2020 National Electrical Code with 2022 California Amendments)	(Part 3, Title 24, CCR)
2022 California Mechanical Code (CMC)	(Part 4, Title 24, CCR)
(2021 IAPMO Uniform Mechanical Code with 2022 California Amendments)	(Part 4, Title 24, CCR)
2022 California Plumbing Code (CPC)	(Part 5, Title 24, CCR)
(2021 IAPMO Uniform Plumbing Code with 2022 California Amendments)	(Part 5, Title 24, CCR)
2022 California Energy Code (CEC)	(Part 6, Title 24, CCR)
2022 California Fire Code (CFC)	(Part 9, Title 24, CCR)
(2021 International Fire Code with 2022 California Amendments)	(Part 9, Title 24, CCR)
2022 California Existing Building Code (CEBC)	(Part 10, Title 24, CCR)
(2021 International Existing Building Code with 2022 California Amendments)	(Part 10, Title 24, CCR)
2022 California Green Building Standards Code (CALGreen)	(Part 11, Title 24, CCR)
2022 California Referenced Standards Code	(Part 12, Title 24, CCR)
Title 19 CCR, Public Safety, State Fire Marshall Regulations	
2019 ASME A17.1/CSA B44-13 Safety Code For Elevators and Escalators (per 2022 CBC Part 2, Ch 35)	
Note: CALIFORNIA Elevator Unit enforces CCR Title 8 and uses the 2004 ASME A17.1 by adoption	
PARTIAL LIST OF APPLICABLE STANDARDS	
NFPA 13 - Standard for the Installation of Sprinkler Systems (as amended) *	(2022 Edition)
NFPA 14 - Standard for the Installation of Standpipe and Hose Systems (as amended) *	(2019 Edition)
NFPA 17 - Standard for Dry Chemical Extinguishing Systems	(2021 Edition)
NFPA 17A - Standard for Wet Chemical Extinguishing Systems	(2021 Edition)
NFPA 20 - Standard for the Installation of Stationary Pumps for Fire Protection	(2019 Edition)
NFPA 22 - Standard for Water Tanks for Private Fire Protection	(2019 Edition)
NFPA 24 - Standard for the Installation of Private Fire Service Mains and Their Appurtenances (as amended) *	(2019 Edition)
NFPA 25 - Standard for the Inspection, Testing, and Maintenance of Water-Based Fire Protection Systems with California Amendments (Based on NFPA 25, 2011 Edition)	(2019 Edition)
NFPA 72 - National Fire Alarm and Signaling Code (as amended) *	(2022 Edition)
NFPA 80 - Fire Doors and Other Opening Protectives	(2019 Edition)
NFPA 92 - Standard for Smoke Control Systems	(2019 Edition)
NFPA 253 - Standard Method of Test for Critical Radiant Flux of Floor Covering Systems Using a Radiant Heat Energy Source	(2019 Edition)
NFPA 2001 - Standard on Clear Agent Fire Extinguishing Systems (as amended) *	(2018 Edition)
ICC 300 - ICC Standard on Seachers, Folding and Telescoping Seating and Grandstands	(2017 Edition)
UL 300 - Standard for Fire Testing of Fire Extinguishing Systems for Protection of Commercial Equipment—with Revisions through December 2014	(2005 (R2010) Edition)
UL 464 - Audible Signal Appliances—with Revisions through October 10, 2003	(2003 Edition)
UL 521 - Heat Detectors for Fire Protective Signaling Systems—with Revisions through July 20, 2005	(1999 Edition)
UL 1971 - Standard for Signaling Devices for the Hearing Impaired	(2018 Edition)
* See CBC Chapter 35, Referenced Standards for State of California amendments to the NFPA Standards. For a complete list of applicable NFPA standards refer to 2022 CBC (SPM) Chapter 35 and California Fire Code (CFC) Chapter 90.	

T-1

TITLE SHEET

C1.0
C2.0
C3.0
C4.0
C5.0
C6.0

COVER
TOPOGRAPHIC SURVEY & BOUNDARY
RETRACEMENT
GRADING PLAN
UTILITY PLAN
EROSION CONTROL PLAN
EROSION CONTROL DETAILS

L1.0
L1.1
L2.0
L2.1
L2.2

PLANTING PLAN & NOTES
PLANTING DETAILS
IRRIGATION PLAN & NOTES
IRRIGATION DETAILS
IRRIGATION DETAILS

A1.1
A2.1
A4.1
A5.1
A5.2
A5.3

PROPOSED SITE PLAN & TREE PLAN
DIMENSIONED FLOOR PLANS
PROPOSED ROOF PLAN
PROPOSED EXTERIOR ELEVATIONS
PROPOSED EXTERIOR ELEVATIONS
PROPOSED BUILDING SECTIONS

E1.1
E1.1P

SITE PLAN
PHOTOMETRIC SITE PLAN



CONDITIONS OF APPROVAL



MONTARA WATER & SANITARY DISTRICT

Serving the Communities of Montara and Moss Beach
P.O. Box 370131 Tel: (650) 728-3545
8888 Cabrillo Highway Fax: (650) 728-8556
Montara, CA 94037-0131 E-mail: mwsd@coastside.net
Visit Our Web Site: <http://www.mwsd.montara.com>

12/14/2023

Recommended Conditions of Approval for PLN2023-00311, APN 037063380, Point Montara Fire, 501 Stetson Street, Moss Beach, CA:

Submit Existing Service Application and pay for the initial application fees based on the remodeling type determined by MWSD. Applicant shall follow the procedures specified in the Existing Service Application Packet.

Video CCTV lower lateral and submit to MWSD (sanitary district) for review. Any defects or pipe that is not to current District code shall be replaced. Current code construction details and additional backflow protection requirements shall apply. Upgrade to 6" lateral is recommended.

15 ft easement width for all MWSD mains is required. The condition of the existing water meter(s), BFP and water lateral connection shall be inspected by MWSD to determine if they are in good working condition; MWSD may require repair or replacement of the existing water meter(s), BFP and water lateral connection. Water meter upgrade may be required.

If connection to the District's fire protection system is required: Certified Fire Protection Contractor must certify adequate fire flow calculations. Connection fee for fire protection system is required. Connection charge must be paid prior to issuance of Private Fire Protection permit.

Applicants must first apply directly to District for permits and not their contractor.

Clemens Heldmaier
MWSD

DPW NOTES

1. AUTOMATIC FIRE SPRINKLERS REQUIRED PER NFPA 13.
2. UNDERGROUND FLUSH IS REQUIRED FOR THIS PROJECT. MUST BE WITNESSED BY FIRE DEPARTMENT.
3. SEPARATE PERMITS REQUIRED FOR GENERATOR, FIRE ALARM, AND FIRE SPRINKLERS.

GOVERNING AGENCIES

COUNTY OF SAN MATEO
PLANNING AND BUILDING DEPARTMENT
400 COUNTY CENTER
REDWOOD CITY, CA 94063
(650) 363-4000

PROJECT DATA

PROJECT ADDRESS:	501 STETSON ST. MOSS BEACH, CA 94038
ASSESSOR'S PARCEL NO.:	037 063 380
ZONING:	R-1/S-17/DR/CD
GOVERNING CODES:	2022 CBC
OCCUPANCY GROUP:	R-2 / S-2 / B
CONSTRUCTION TYPE:	V-B
TOTAL BUILDING AREA:	10,178 SF
TOTAL SITE AREA:	21,695 SF
NUMBER OF STORIES:	2
PARKING:	
ACCESSIBLE:	1
STANDARD PUBLIC:	1
STAFF:	7
TOTAL:	9

LOT COVERAGE:
MAX. ALLOWED: 35%
PROPOSED: 7,025 SF (BLDG. FOOTPRINT) / 21,695 (SITE AREA) = 32.4 %
32.4% < 35% OK

FLOOR AREA RATIO:
MAX. ALLOWED: 6,200 SF (PER S-17 ZONE)
PROPOSED: 10,178 SF (SEE A2.1 FOR FLOOR AREA CALCULATION)
FLOOR AREA RATIO = 10,178 SF / 21,695 SF = 0.47

BUILDING HEIGHT:
MAX. ALLOWED: 28 FEET TYP.
PROPOSED: 28'-0"

SQUARE FOOTAGE OF LANDSCAPING:
NEW: 3,914 SF
REHABILITATED: 0 SF

PROJECT TEAM

OWNER	ARCHITECT
COASTSIDE FIRE PROTECTION DISTRICT 555 OBISPO RD. HALF MOON BAY, CA 94018 650-726-5213 PH	PBK 1327 ARCHER STREET SUITE 110 SAN LUIS OBISPO, CA 93401 805-329-3076 PH
CIVIL ENGINEER	ELECTRICAL ENGINEER
MCR ENGINEERING 1322 DUPONT CT. MANTECA, CA 95336 209-239-6229 PH	A & F ENGINEERING GROUP INC. 3320 BASELINE ROAD, SUITE C RANCHO CUCAMONGA, CA 91701 909-941-3008 PH
GEOTECHNICAL ENGINEER	LANDSCAPE ARCHITECT
GEOCON CONSULTANTS, INC. 8671 BRISA STREET LIVERMORE, CA 94550 925-371-5900 PH	WDSLA 150 MISSION ST SAN FRANCISCO, CA 94102 916-907-2942 PH

VICINITY MAP



FIRE STATION #44
COASTSIDE FIRE PROTECTION DISTRICT

501 STETSON STREET
MOSS BEACH, CA 94038
PLANNING SUBMITTAL



G	H	J
D	E	F
A	B	C

KEY PLAN



CLIENT COASTSIDE FIRE PROTECTION DISTRICT		
PROJECT NUMBER 230137		
DATE	5/22/2024	
DRAWN BY:	KF/OS	CHECKED BY: AD
REVISIONS		
#	DESCRIPTION	DATE
PLANNING SUBMITTAL		

TITLE SHEET

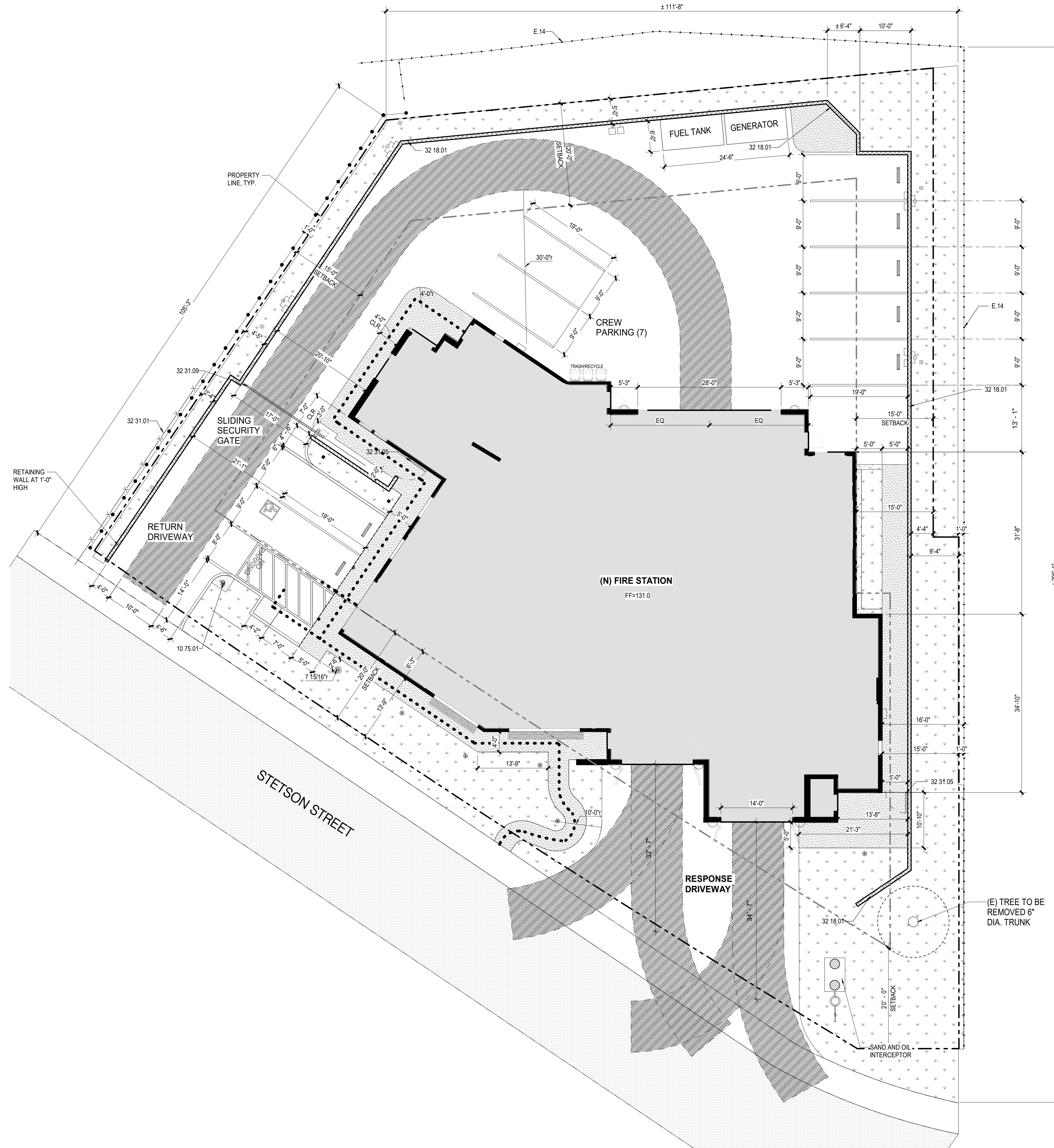

KEYNOTE LEGEND

10 75.01	FLAGPOLE
32 18.01	RETAINING WALL VARIES IN HEIGHT. SEE CIVIL DRAWINGS
32 31.01	(N) WOOD FENCING
32 31.05	METAL FENCE GATE
32 31.09	SLIDING SECURITY GATE
E.14	(E) WOOD FENCE TO REMAIN

PBK
 ARCHITECT PBK Architects, Inc.
 SAN LUIS OBISPO
 1327 Archer Street, Suite 110
 San Luis Obispo, CA 93401
 805-328-3076

FIRE STATION #44
 COASTSIDE FIRE PROTECTION DISTRICT
 501 STETSON STREET
 MOSS BEACH, CA 94038
 PLANNING SUBMITTAL



G	H	J
D	E	F
A	B	C

KEY PLAN
 PLAN NORTH
 TRUE NORTH

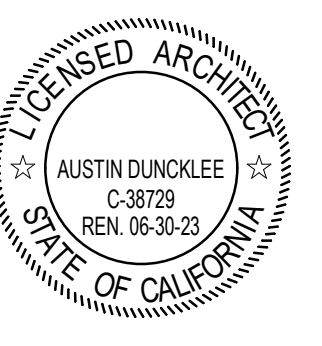

CLIENT: COASTSIDE FIRE PROTECTION DISTRICT
 PROJECT NUMBER: 230137
 DATE: 5/22/2024
 DRAWN BY: KF/OS CHKED BY: AD

#	REVISIONS DESCRIPTION	DATE

PLANNING SUBMITTAL

PROPOSED SITE PLAN & TREE PLAN

A1.1

PLANNING SUBMITTAL

SITE PLAN NOTES

- REFER TO CIVIL DOCUMENTS FOR GRADING & UTILITY INFORMATION. SEE SHEET 02.0.
- COORD. ALL SPOT ELEVATIONS AND DIMENSIONS WITH CIVIL, LANDSCAPE, AND/OR STRUCTURAL DOCUMENTS.
- PROVIDE AND INSTALL POSITIVE DRAINAGE AWAY FROM ALL BUILDINGS OF 1% MINIMUM, 2% MAXIMUM AT ALL EXTERIOR PAVED PEDESTRIAN AREAS, INCLUDING BUT NOT LIMITED TO, SIDEWALKS, PATIOS, STAIRS, PAVING, U.N.O.
- PROVIDE AND INSTALL POSITIVE DRAINAGE AWAY FROM ALL BUILDINGS OF 3% FOR A HORIZ. DISTANCE OF 10 FEET AT ALL EXTERIOR NON-PAVED AREAS U.N.O.
- REFER TO CIVIL DOCUMENTS FOR CONCRETE SIDEWALK EXPANSION JOINTS AND CONCRETE SIDEWALK CONTROL JOINTS.
- VERIFY AND CONFIRM ALL JOINT LAYOUTS AT ALL CONCRETE SIDEWALKS (WITH AFCH, PRIOR TO POURING OF CONCRETE).
- PROVIDE AND INSTALL CONCRETE SIDEWALK EXPANSION JOINTS AT AREAS NOT SPECIFICALLY INDICATED AT 50 FEET ON-CENTER MAX. U.N.O.
- PROVIDE AND INSTALL CONCRETE SIDEWALK CONTROL JOINTS AT AREAS NOT SPECIFICALLY INDICATED AT DISTANCES EQUIVALENT TO SIDEWALK WIDTH, BUT NOT TO EXCEED 10 FEET ON-CENTER MAX.
- VERIFY ALL SITE SIGNAGE LOCATIONS WITH ARCH. PRIOR TO INSTALLATION OF SITE SIGNAGE.

	CONCRETE PAVING		(E) FIRE HYDRANT
	LANDSCAPED AREA		PROPOSED FIRE HYDRANT RE. CIVIL
	PROPOSED BUILDING		FIRE DEPARTMENT CONNECTION
	PROPOSED FIRE ACCESS LANE		BUILDING ID SIGN
	8' CMU RETAINING WALL		8' CMU WALL
	PROPERTY LINE		PROPOSED (N) WOOD LINK FENCE
	ACCESSIBLE PATH OF TRAVEL		6'-0" (E) HIGH WOOD FENCE

LEGEND - SITE PLAN
 SCALE: 1/4" = 1'-0"

This document is for plan review only



ARCHITECT
 SAN LUIS OBISPO
 1327 Archer Street, Suite 110
 San Luis Obispo, CA 93401
 805-328-3076

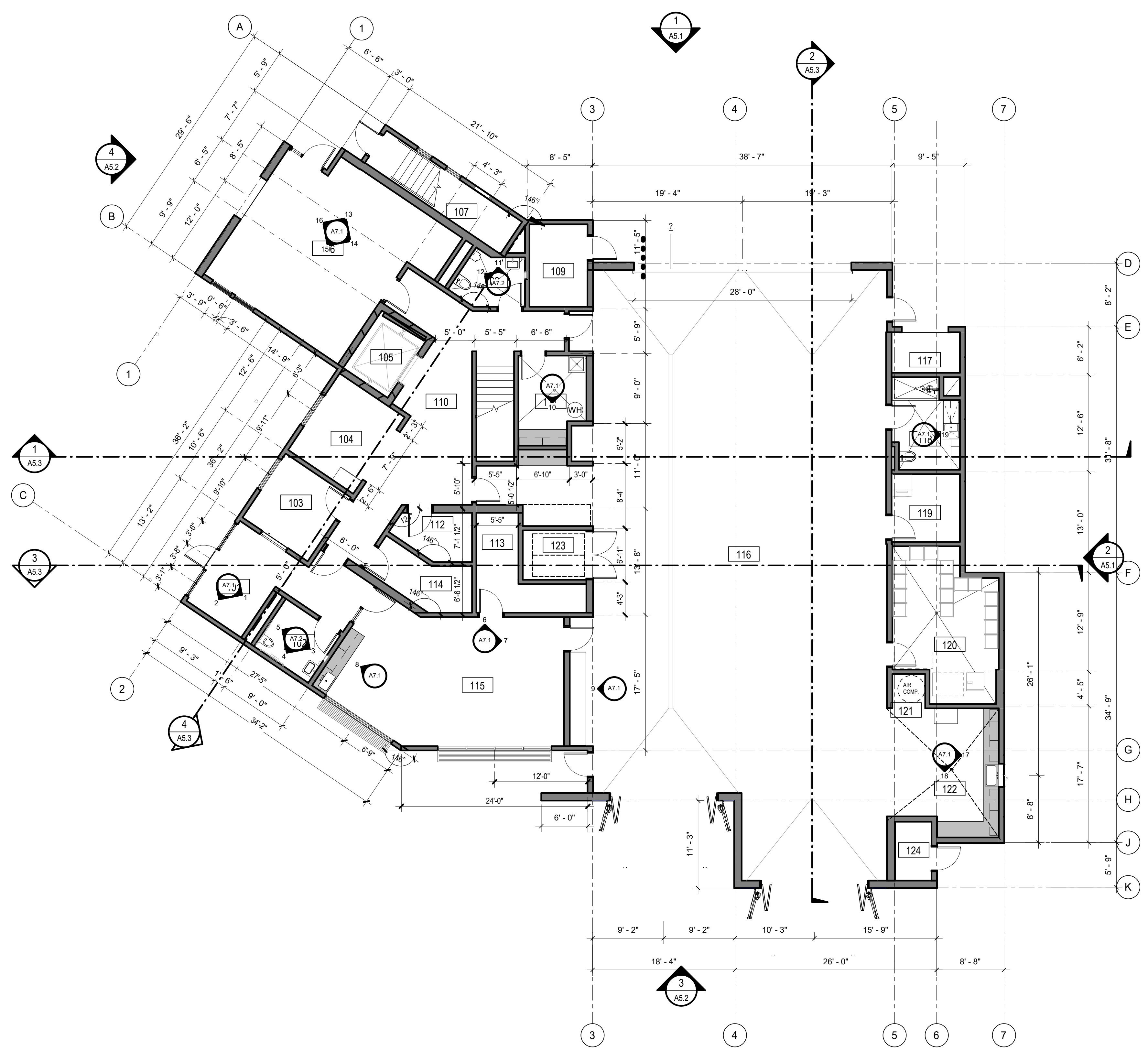

FIRST FLOOR GROSS AREA = 6,612 SF

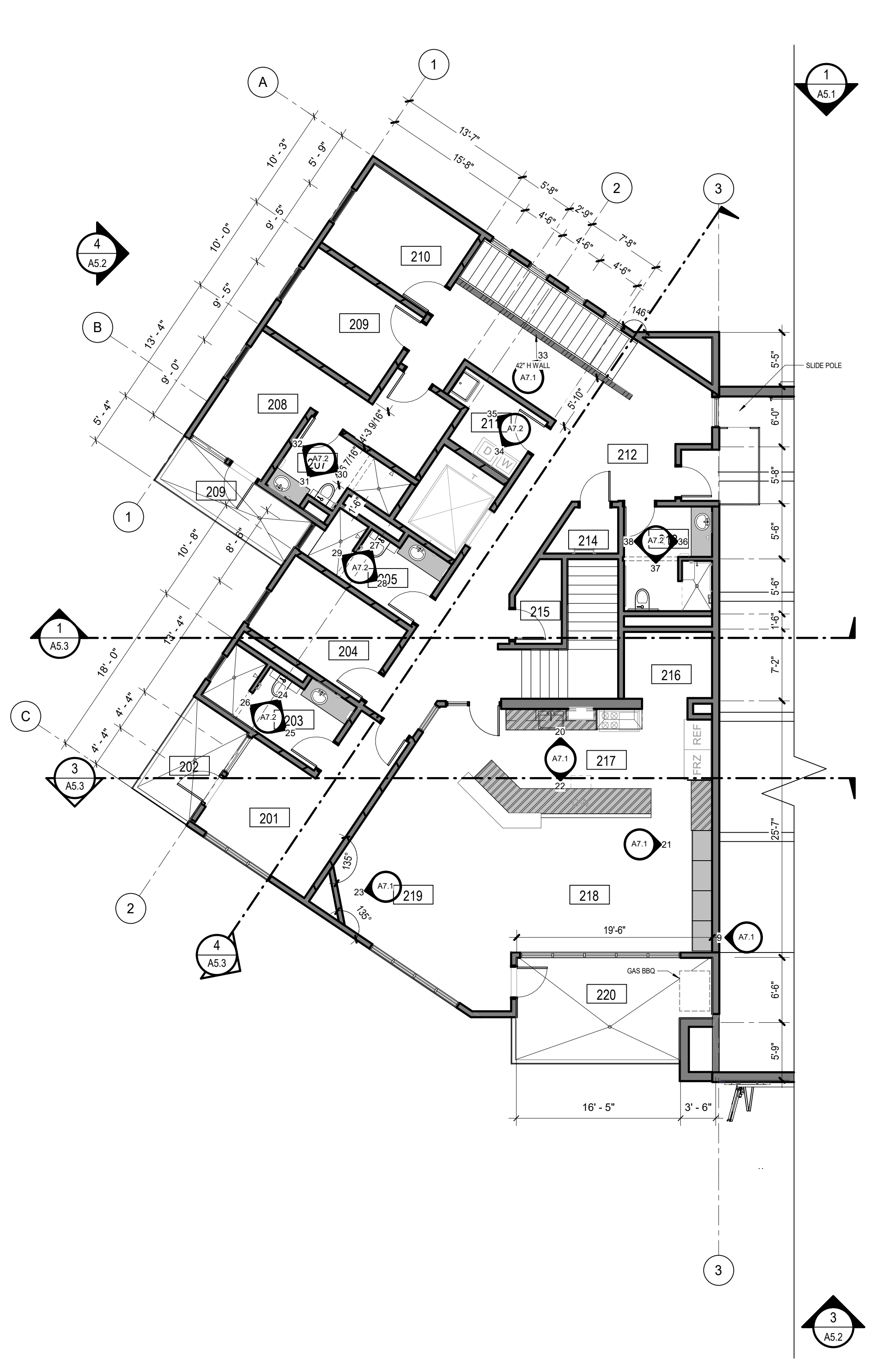

SECOND FLOOR GROSS AREA = 3,566 SF

PLANNING SUBMITTAL

1 FP01 - FIRST FLOOR DIMENSION PLAN
 SCALE: 1/8" = 1'-0"

ROOM SCHEDULE FIRST FLOOR		
Name	Number	Area
LOBBY	101	174 SF
RR 1	102	62 SF
CAPT. OFFICE	103	100 SF
OFFICE	104	124 SF
ELEV	105	59 SF
FITNESS	106	476 SF
STAIRWAY 1	107	105 SF
RR	108	56 SF
ELECT	109	79 SF
HALLWAY	110	375 SF
CUST	111	94 SF
EL MACH	112	55 SF
STOR	113	102 SF
TELECOM	114	77 SF
TRAINING CLASSROOM	115	483 SF
APPARATUS BAY	116	2,954 SF
YARD ST	117	46 SF
DECON	118	94 SF
EMS STOR	119	77 SF
TURNOUT	120	235 SF
COMP	121	19 SF

ROOM SCHEDULE FIRST FLOOR		
Name	Number	Area
SHOP	122	222 SF
HOSE DRY STOR	123	52 SF
FR	124	36 SF

ROOM SCHEDULE SECOND FLOOR		
Name	Number	Area
BAT. CHIEF	201	186 SF
BALCONY	202	66 SF
BC RR	203	91 SF
DORM 1	204	116 SF
RR	205	84 SF
ELEV	206	66 SF
RR 3	207	73 SF
CAPTAIN	208	185 SF
DORM 2	209	120 SF
BALCONY	209	73 SF
DORM 3	210	120 SF
LAUNDRY	211	59 SF
HALLWAY	212	559 SF
ACCESSIBLE RR	213	91 SF
VEST	214	27 SF
STOR 3	215	35 SF
PANTRY	216	61 SF
KITCHEN	217	302 SF
DINING	218	215 SF
DAYROOM	219	347 SF
DECK	220	185 SF

2 FP02 - SECOND FLOOR DIMENSION PLAN
 SCALE: 1/8" = 1'-0"

KEYNOTE LEGEND	
(Symbol)	NEW PARTITION
(Symbol)	PARTITION TYPE REFER TO SHEET AT-00 FOR DEFINITION
(Symbol)	1 HR FIRE RATING
(Symbol)	42" HIGH WALL
(Symbol)	DOOR DESIGNATION
(Symbol)	WINDOW DESIGNATION
(Symbol)	STAINLESS STEEL COUNTERTOPS

FLOOR PLAN LEGEND	
(Symbol)	ROOM NAME
(Symbol)	ROOM NAME & NUMBER
(Symbol)	NEW PARTITION
(Symbol)	PARTITION TYPE REFER TO SHEET AT-00 FOR DEFINITION
(Symbol)	1 HR FIRE RATING
(Symbol)	42" HIGH WALL
(Symbol)	DOOR DESIGNATION
(Symbol)	WINDOW DESIGNATION
(Symbol)	STAINLESS STEEL COUNTERTOPS

- GENERAL FLOOR PLAN NOTES**
- DO NOT SCALE DRAWINGS. WRITTEN DIMENSIONS TAKE PRECEDENCE. CONTACT ARCH IF CLARIFICATION IS NECESSARY IN ORDER TO DETERMINE THE INTENT OF THE CONTRACT DOCUMENTS.
 - DRAWINGS NOTED AS "N.T.S." OR "N.T.S." ARE NOT TO SCALE.
 - ALL DIMENSIONS ARE TO STRUCTURAL COLUMN LINES OR THE SURFACE OF PARTITION ASSEMBLY U.N.O.
 - FIELD VERIFY ALL DIMENSIONS AND EXISTING CONDITION BEFORE COMMENCING WORK. NOTIFY ARCH. OF ANY DISCREPANCIES PRIOR TO PROCEEDING WITH AFFECTED WORK.
 - NOTES OR DIMENSIONS NOTED AS "TYPICAL" OR "TYP." OR "TYP." SHALL APPLY TO CONDITIONS THAT ARE THE SAME OR SIMILAR.
 - DIMENSIONS NOTED AS "FIELD VERIFY" OR "V.I.F." OR "V.I.F." SHALL BE MEASURED AND CONFIRMED AT THE PROJECT SITE BY THE CONTRACTOR AND REVIEWED WITH THE ARCH. BEFORE INCORPORATING INTO THE WORK.
 - DIMENSIONS NOTED AS "CLEAR" OR "CLEAR INSIDE" REQUIRE SPECIFIC COORDINATION AMONG DISCIPLINES AND/OR MANUFACTURERS.
 - REFER TO PARTITION TYPES ON AT-00 SERIES SHEETS.
 - ALL INTERIOR PARTITIONS THIS SHEET, EXCEPT FOR FURR-OUT PARTITIONS, SHALL BE PARTITION TYPE U.N.O.
 - ALL INTERIOR FURR-OUT PARTITIONS THIS SHEET SHALL BE PARTITION TYPE U.N.O. OR ADJOIN IN THE SAME PLANE.
 - ALL DOORS SHALL BE SET 6 INCHES OFF THE ADJACENT PERPENDICULAR WALL ON THE HINGE SIDE OF THE DOOR U.N.O., NOTIFY ARCH. OF ANY DOOR-RELATED CONFLICTS, INCLUDING BUT NOT LIMITED TO CONFLICTS CONCERNING ACCESSIBILITY STANDARDS.
 - ALL DOOR THRESHOLDS AT ALL EXTERIOR DOORS SHALL BE SET IN FULL BED OF SEALANT.
 - COORD. ALL ROOF DRAIN LEADER LOCATIONS WITH FLOOR PLAN PRIOR TO FLOOR SLAB CONSTRUCTION.
 - ALL FLOOR SLOPES TO FLOOR DRAINS SHALL NOT EXCEED 1/48.
 - PROVIDE AND INSTALL SELF-LEVELING UNDERLAYMENT WHERE UNEVEN FLOOR SLAB EXISTS PRIOR TO INSTALLATION OF FLOOR FINISHES.
 - COORD. HOUSEKEEPING PAD LOCATIONS AND DIMENSIONS WITH EQUIPMENT TO BE INSTALLED.
 - ALL FLOOR FINISH CHANGES SHALL OCCUR AT THE CENTERLINE OF DOORS U.N.O.
 - ALL FLOOR FINISH MATERIAL CHANGES SHALL HAVE REDUCER STRIPS.
 - ALL REQUIRED ACCESSIBLE CLEARANCES FOR ALL ITEMS, INCLUDING BUT NOT LIMITED TO ALL COUNTER TOPS, ALL PLUMBING FIXTURES, ALL DRINKING FOUNTAINS, ALL ELECTRIC WATER COOLERS, ALL LAVATORIES, ALL URINALS, ALL TOILETS SHALL BE STRICTLY ENFORCED.
 - REFER TO OTHER DISCIPLINE DOCUMENTS FOR ADDITIONAL SCOPE OF WORK.

FIRE STATION #44
 COASTSIDE FIRE PROTECTION DISTRICT



501 STETSON STREET
 MOSS BEACH, CA 94038

G	H	J
D	E	F
A	B	C

KEY PLAN
 PLAN NORTH
 TRUE NORTH

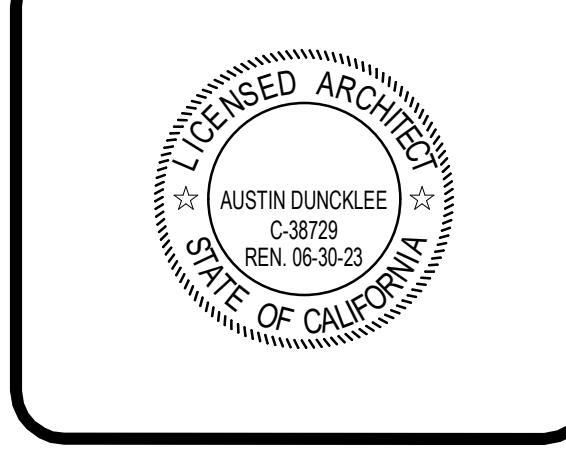

REVISIONS		
#	DESCRIPTION	DATE

CLIENT: COASTSIDE FIRE PROTECTION DISTRICT
 PROJECT NUMBER: 230137
 DATE: 5/22/2024
 DRAWN BY: KF/OS
 CHECKED BY: AD

PLANNING SUBMITTAL

DIMENSIONED FLOOR PLANS

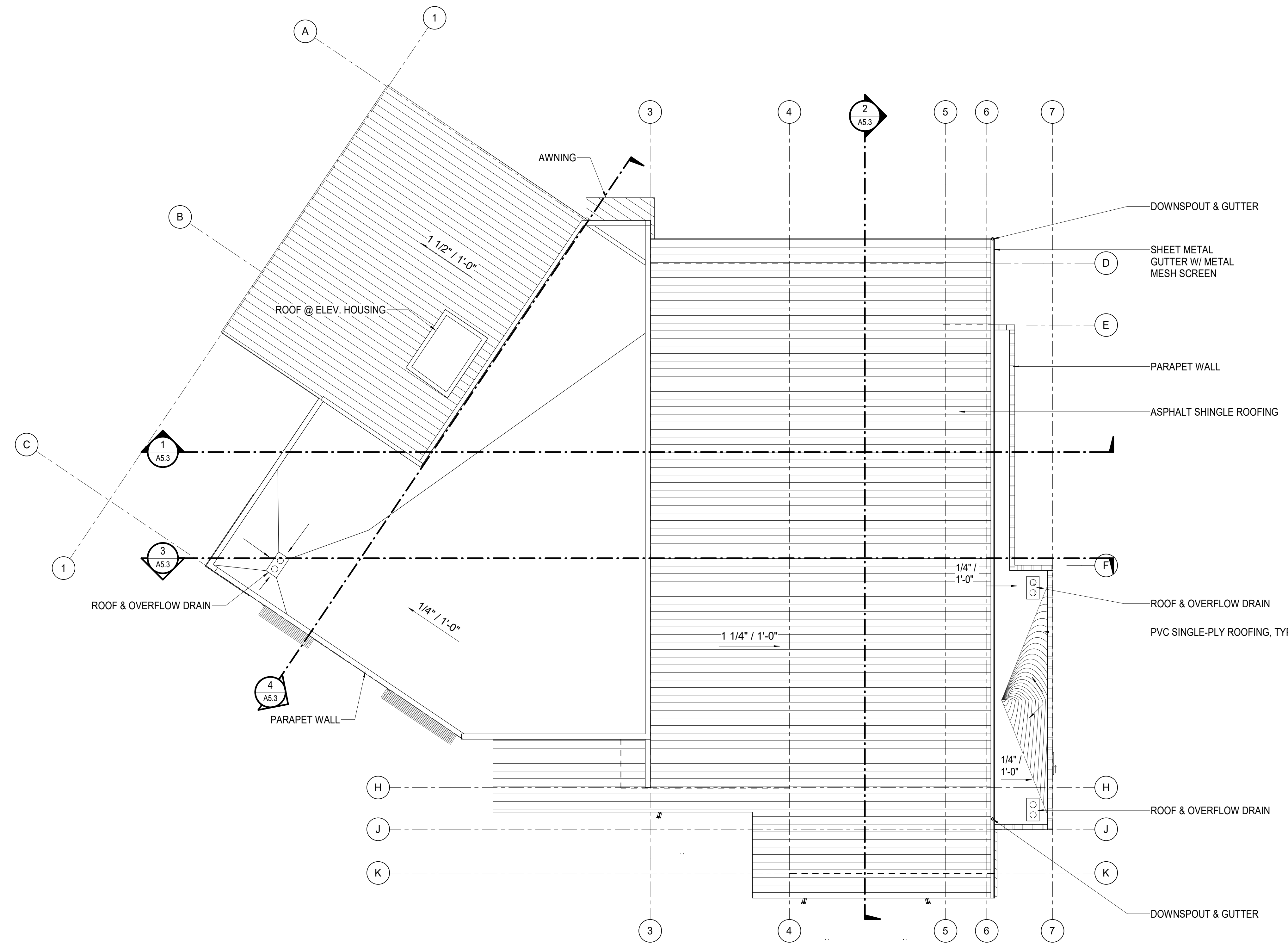

ROOF PLAN LEGEND

KEYNOTE LEGEND

PLANNING SUBMITTAL

GENERAL NOTES

- ROOF PLAN NOTES:
- ALL HEIGHTS ARE REFERENCED FROM FINISH FLOOR ELEVATION = 0'-0". REFER TO PLANS AND SECTIONS FOR ADDITIONAL INFORMATION.
 - FOR ADDITIONAL CONDUIT AND PIPING PENETRATIONS AT ROOF AREAS, SEE MECHANICAL, PLUMBING, AND ELECTRICAL DRAWINGS. FOR DETAIL AT METAL STUD FRAMED AREAS, SEE DETAILS 1 AND 2.
 - SEE DETAIL FOR ROOF TOP EQUIPMENT CRICKET.
 - SEE DETAIL FOR FLASHING AT INTERSECTING WALLS.
 - PROVIDE MINIMUM 1/2" PER FOOT ROOF SLOPE FOR DRAINAGE AT ALL FLAT ROOF LOCATIONS.
 - PROVIDE SPLASH BLOCK FOR GUTTER DOWNSPOUTS TERMINATING AT FLAT ROOF. SEE DETAIL.

1 ROOF PLAN
SCALE: 1/8" = 1'-0"



ARCHITECT PBK Architects, Inc.
 SAN LUIS OBISPO
 1327 Archer Street, Suite 110
 San Luis Obispo, CA 93401
 805-328-3076

FIRE STATION #44
 COASTSIDE FIRE PROTECTION DISTRICT

501 STETSON STREET
 MOSS BEACH, CA 94038



G	H	J
D	E	F
A	B	C

KEY PLAN

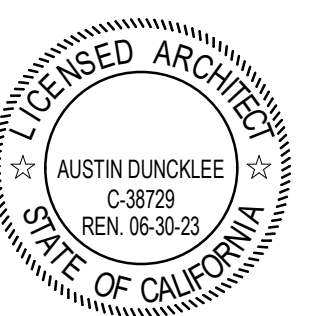

CLIENT	
COASTSIDE FIRE PROTECTION DISTRICT	
PROJECT NUMBER	
230137	
DATE	4/10/2024
DRAWN BY:	KF/OS
CHECKED BY:	AD
REVISIONS	
#	DESCRIPTION

PLANNING SUBMITTAL

PROPOSED ROOF PLAN

Not for permitting or construction. This document is for plan review only.



G	H	J
D	E	F
A	B	C

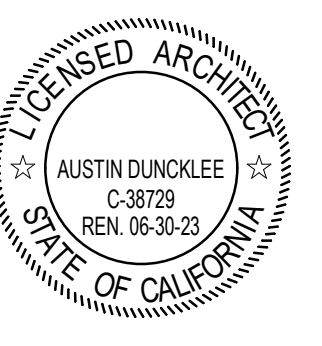

CLIENT	COASTSIDE FIRE PROTECTION DISTRICT	
PROJECT NUMBER	230137	
DATE	4/10/2024	
DRAWN BY:	KF/OS	
CHECKED BY:	AD	
REVISIONS		
#	DESCRIPTION	DATE

PLANNING SUBMITTAL
PROPOSED EXTERIOR ELEVATIONS

Not for permitting or construction

PLANNING SUBMITTAL

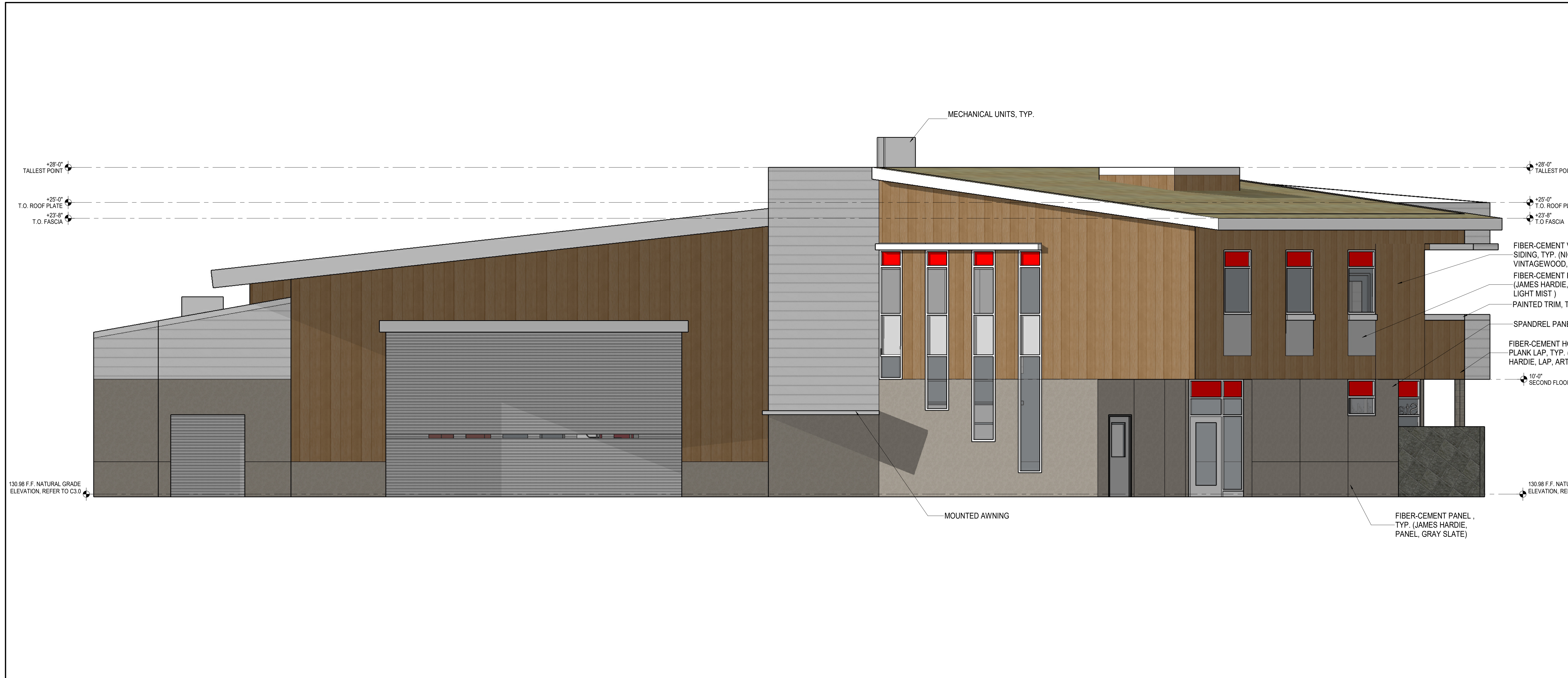

1 EXTERIOR ELEVATION - NORTH
 SCALE: 1/4" = 1'-0"

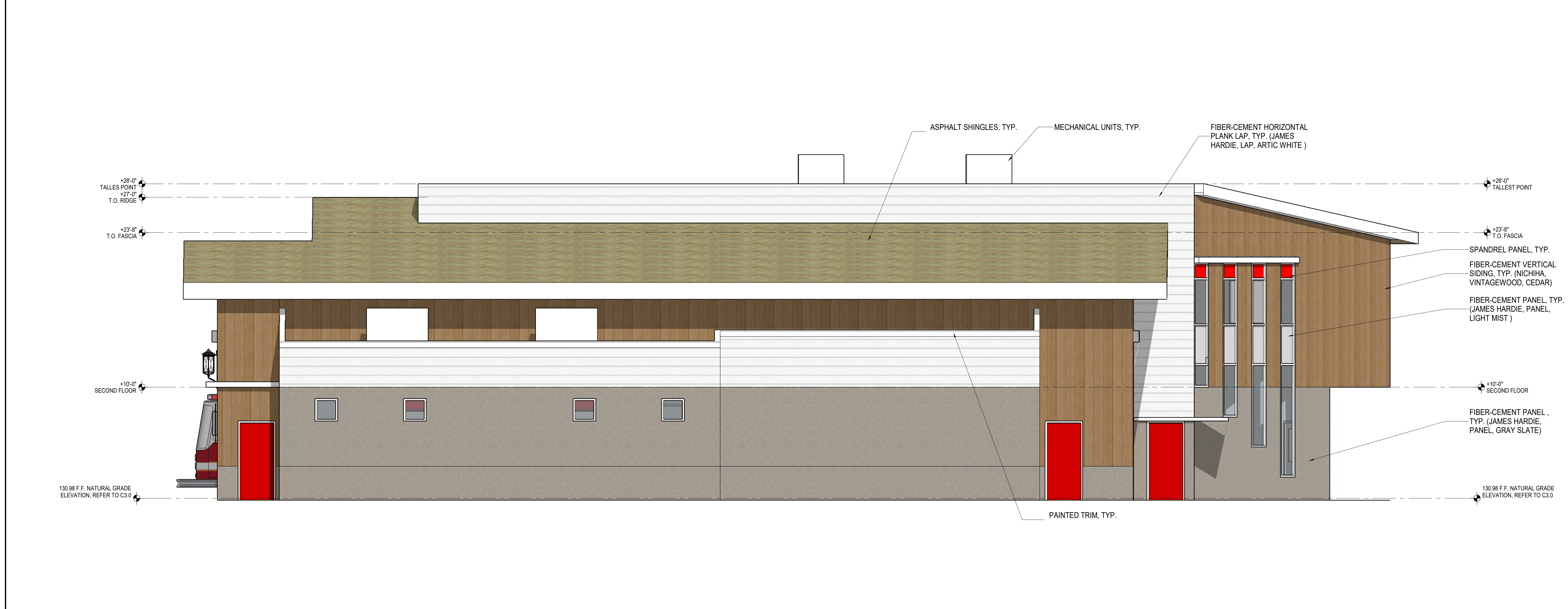

2 EXTERIOR ELEVATION - EAST
 SCALE: 1/4" = 1'-0"



G	H	J
D	E	F
A	B	C

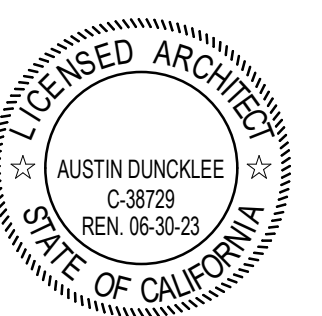

CLIENT COASTSIDE FIRE PROTECTION DISTRICT		
PROJECT NUMBER 230137		
DATE 4/10/2024		
DRAWN BY: KF/OS CHECKED BY: AD		
REVISIONS		
#	DESCRIPTION	DATE

PLANNING SUBMITTAL
PROPOSED EXTERIOR ELEVATIONS

This document is for plan review only

PLANNING SUBMITTAL



3 EXTERIOR ELEVATION - SOUTH
SCALE: 1/4" = 1'-0"

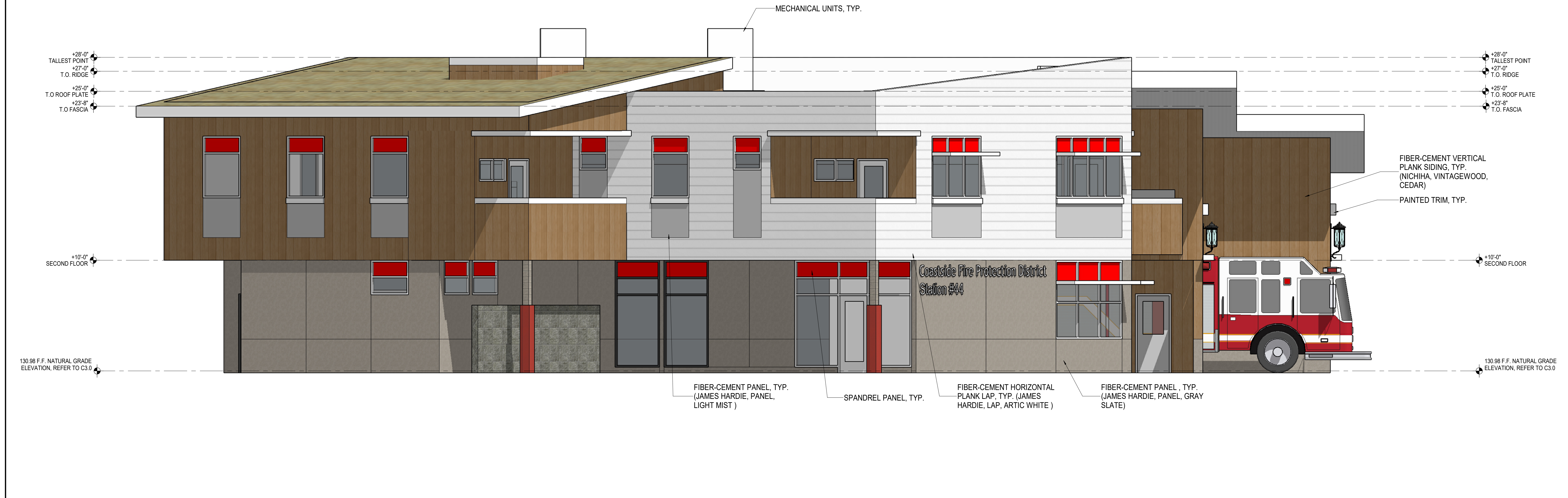

4 EXTERIOR ELEVATION - WEST
SCALE: 1/4" = 1'-0"



G	H	J
D	E	F
A	B	C

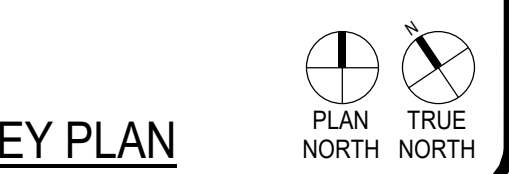

KEY PLAN
 PLAN NORTH

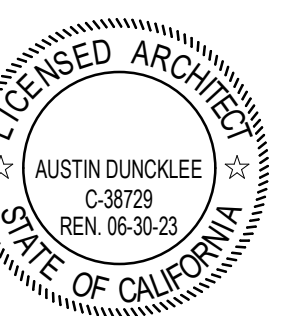

CLIENT	COASTSIDE FIRE PROTECTION DISTRICT	
PROJECT NUMBER	230137	
DATE	4/10/2024	
DRAWN BY:	KF/OS	
CHECKED BY:	AD	
REVISIONS		
#	DESCRIPTION	DATE

PLANNING SUBMITTAL

PROPOSED BUILDING SECTIONS

Not for permitting or construction

PLANNING SUBMITTAL

ROOM SCHEDULE FIRST FLOOR - SECTION	
Name	Number
LOBBY	101
RR 1	102
CAPT. OFFICE	103
OFFICE	104
ELEV	105
FITNESS	106
STAIRWAY 1	107
RR	108
ELECT	109
HALLWAY	110
CUST	111
EL MACH	112
STOR	113
TELECOM	114
TRAINING CLASSROOM	115
APPARATUS BAY	116
YARD ST	117
DECON	118
EMS STOR	119
TURNOUT	120
COMP	121
SHOP	122
HOSE DRY STOR	123
FR	124

ROOM SCHEDULE SECOND FLOOR - SECTION	
Name	Number
BAT. CHIEF	201
BALCONY	202
BC RR	203
DORM 1	204
RR	205
ELEV	206
RR 3	207
CAPTAIN	208
DORM 2	209
BALCONY	209
DORM 3	210
LAUNDRY	211
HALLWAY	212
ACCESSIBLE RR	213
VEST	214
STOR 3	215
PANTRY	216
KITCHEN	217
DINING	218
DAYROOM	219
DECK	220

GENERAL NOTES

- ALL EXTERIOR AND ROOF ASSEMBLIES ARE INSULATED.
- PROVIDE R-19 INSULATION AT WALLS.
- PROVIDE SOLID BACKING IN WALL AT ALL LOCATIONS OF WALL MOUNTED ITEMS.
- REFER TO FINISH SCHEDULE A7.02-2 FOR ADDITIONAL FINISH INFO.
- SECOND FLOOR 1-HR RATING PER U.L. DES D216. SEE A8.20-2 FOR FLOOR-CEILING ASSEMBLY, AND PENETRATION FIRESTOPPING THROUGH FLOOR.

MATERIALS LEGEND

	1-HR FIRE RATED ASSEMBLY
	MS-1 EXTERIOR METAL SIDING 1
	MS-2 EXTERIOR METAL SIDING 2 REGAL RED
	MS-3 EXTERIOR METAL SIDING 3 SANDSTONE
	MS-4 EXTERIOR METAL SIDING 4 BLACK
	MS-5 EXTERIOR METAL SIDING 5 ASH GRAY
	FRP-3 FIBERGLASS REINFORCED PANEL
	TB-1 TACKABLE WALL SURFACE
	RB-1 RUBBER BASE

KEYNOTE LEGEND

INSULATION SCHEDULE

1. R-30:	AT ALL ROOF (RIGID INSULATION)
2. R-21:	AT ALL EXTERIOR WALLS AND ALL APPARATUS ROOM WALLS
3. R-19:	ACOUSTICAL BATT INSULATION AT ALL OTHER INTERIOR 6" WALLS

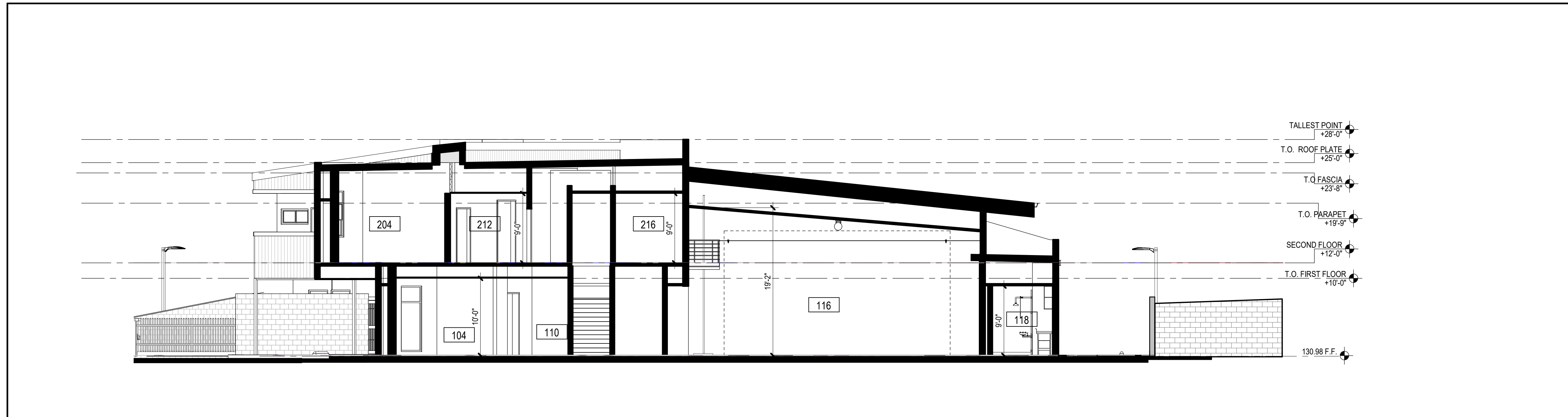

1 BUILDING SECTION 1
 SCALE: 1/8" = 1'-0"

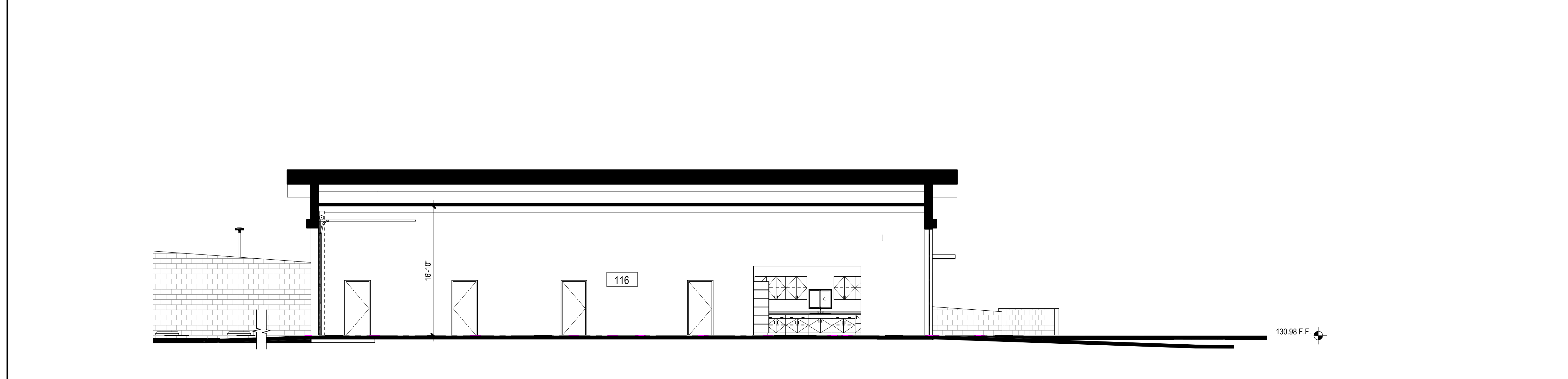

2 BUILDING SECTION 2
 SCALE: 1/8" = 1'-0"

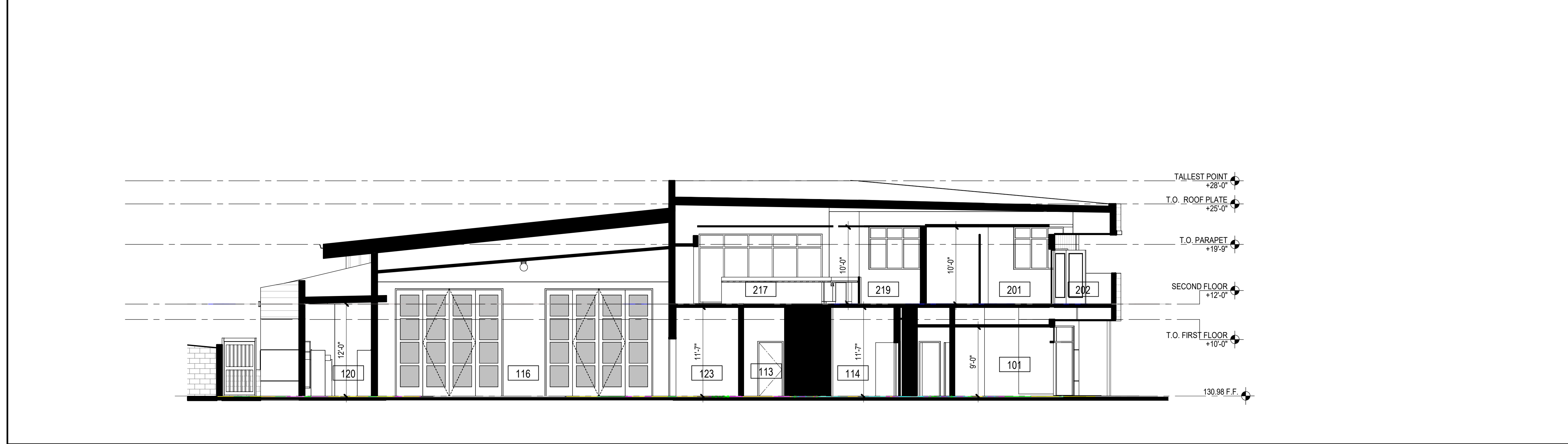

3 BUILDING SECTION 3
 SCALE: 1/8" = 1'-0"

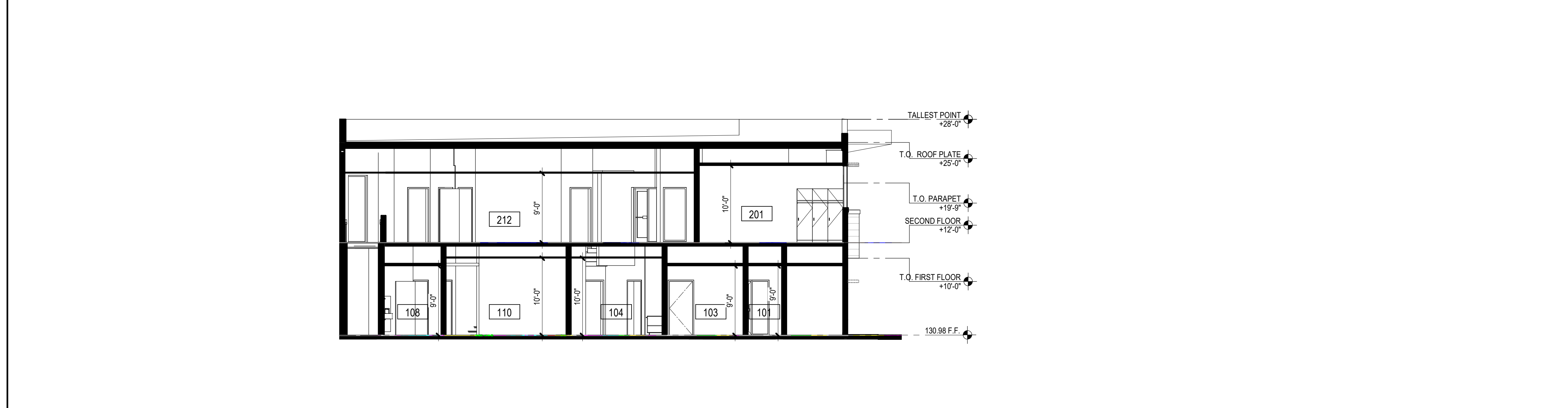

4 BUILDING SECTION 4
 SCALE: 1/8" = 1'-0"



WPX LED Wall Packs



Catalog Number	
Notes	
Type	Type SA

Hit the Tab key or mouse over the page to see all interactive elements.

Specifications

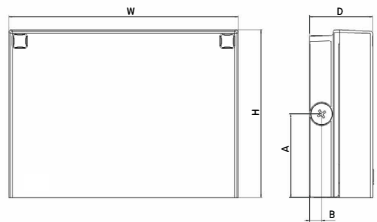

Front View

Side View

Luminaire	Height (H)	Width (W)	Depth (D)	Side Conduit Location		Weight
				A	B	
WPX1	8.1" (20.6 cm)	11.1" (28.3 cm)	3.2" (8.1 cm)	4.0" (10.3 cm)	0.6" (1.6 cm)	6.1 lbs (2.8kg)
WPX2	9.1" (23.1 cm)	12.3" (31.1 cm)	4.1" (10.5 cm)	4.5" (11.5 cm)	0.7" (1.7 cm)	8.2 lbs (3.7kg)
WPX3	9.5" (24.1 cm)	13.0" (33.0 cm)	5.5" (13.7 cm)	4.7" (12.0 cm)	0.7" (1.7 cm)	11.0 lbs (5.0kg)

Introduction

The WPX LED wall packs are energy-efficient, cost-effective, and aesthetically appealing solutions for both HID wall pack replacement and new construction opportunities. Available in three sizes, the WPX family delivers 1,550 to 9,200 lumens with a wide, uniform distribution.

The WPX full cut-off solutions fully cover the footprint of the HID glass wall packs that they replace, providing a neat installation and an upgraded appearance. Reliable IP66 construction and excellent LED lumen maintenance ensure a long service life. Photocell and emergency egress battery options make WPX ideal for every wall mounted lighting application.

Ordering Information

EXAMPLE: WPX2 LED 40K MVOLT DDBXD

Series	Color Temperature	Voltage	Options	Finish	
WPX1 LED P1	1,550 Lumens, 11W ¹	30K 3000K	MVOLT 120V - 277V	(blank) None	DDBXD Dark bronze
WPX1 LED P2	2,900 Lumens, 24W	40K 4000K	347 347V ³	E4WH Emergency battery backup, CEC compliant (4W, 0°C min) ²	DWHXD White
WPX2 LED	6,000 Lumens, 47W	50K 5000K		E14WC Emergency battery backup, CEC compliant (14W, -20°C min) ²	DBLXD Black
WPX3 LED	9,200 Lumens, 69W			PE Photocell ³	Note : For other options, consult factory.

Note: The lumen output and input power shown in the ordering tree are average representations of all configuration options. Specific values are available on request.

NOTES

- All WPX wall packs come with 6kV surge protection standard, except WPX1 LED P1 package which comes with 2.5kV surge protection standard. Add SPD6KV option to get WPX1 LED P1 with 6kV surge protection. Sample nomenclature: WPX1 LED P1 40K MVOLT SPD6KV DDBXD
- Battery pack options only available on WPX1 and WPX2.
- Battery pack options not available with 347V or PE options.

FEATURES & SPECIFICATIONS

INTENDED USE

The WPX LED wall packs are designed to provide a cost-effective, energy-efficient solution for the one-for-one replacement of existing HID wall packs. The WPX1, WPX2 and WPX3 are ideal for replacing up to 150W, 250W, and 400W HID luminaires respectively. WPX luminaires deliver a uniform, wide distribution. WPX is rated for -40°C to 40°C.

CONSTRUCTION

WPX feature a die-cast aluminum main body with optimal thermal management that both enhances LED efficacy and extends component life. The luminaires are IP66 rated, and sealed against moisture or environmental contaminants.

ELECTRICAL

Light engine(s) configurations consist of high-efficacy LEDs and LED lumen maintenance of L90/100,000 hours. Color temperature (CCT) options of 3000K, 4000K and 5000K with minimum CRI of 70. Electronic drivers ensure system power factor >90% and THD <20%. All luminaires have 6kV surge protection (Note: WPX1 LED P1 package comes with a standard surge protection rating of 2.5kV. It can be ordered with an optional 6kV surge protection). All photocell (PE) operate on MVOLT (120V - 277V) input.

Note: The standard WPX LED wall pack luminaires come with field-adjustable drive current feature. This feature allows tuning the output current of the LED drivers to adjust the lumen output (to dim the luminaire).

INSTALLATION

WPX can be mounted directly over a standard electrical junction box. Three 1/2 inch conduit ports on three sides allow for surface conduit wiring. A port on the back surface allows poke-through conduit wiring on surfaces that don't have an electrical junction box. Wiring can be made in the integral wiring compartment in all cases. WPX is only recommended for installations with LEDs facing downwards.

LISTINGS

CSA Certified to meet U.S. and Canadian standards. Suitable for wet locations. IP66 Rated. DesignLights Consortium® (DLC) qualified product. Not all versions of this product may be DLC qualified. Please check the DLC Qualified Products List at www.designlights.org/QPL to confirm which versions are qualified. International Dark Sky Association (IDA) Fixture Seal of Approval (FSA) is available for all products on this page utilizing 3000K color temperature only.

WARRANTY

5-year limited warranty. This is the only warranty provided and no other statements in this specification sheet create any warranty of any kind. All other express and implied warranties are disclaimed. Complete warranty terms located at: www.acuitybrands.com/CustomerResources/Terms_and_conditions.aspx.

Note: Actual performance may differ as a result of end-user environment and application. All values are design or typical values, measured under laboratory conditions at 25°C. Specifications subject to change without notice.



Performance Data

Electrical Load

Luminaire	Input Power (W)	120V	208V	240V	277V	347V
WPX1 LED P1	11W	0.09	0.05	0.05	0.04	0.03
WPX1 LED P2	24W	0.20	0.12	0.10	0.09	0.07
WPX2	47W	0.39	0.23	0.20	0.17	0.14
WPX3	69W	0.58	0.33	0.29	0.25	0.20

Projected LED Lumen Maintenance

Data references the extrapolated performance projections in a 25°C ambient, based on 6,000 hours of LED testing (tested per IESNA LM-80-08 and projected per IESNA TM-21-11).

To calculate LLF, use the lumen maintenance factor that corresponds to the desired number of operating hours below. For other lumen maintenance values, contact factory.

Operating Hours	50,000	75,000	100,000
Lumen Maintenance Factor	>0.94	>0.92	>0.90

Lumen Output

Luminaire	Color Temperature	Lumen Output
WPX1 LED P1	3000K	1,537
	4000K	1,568
	5000K	1,602
WPX1 LED P2	3000K	2,748
	4000K	2,912
	5000K	2,954
WPX2	3000K	5,719
	4000K	5,896
	5000K	6,201
WPX3	3000K	8,984
	4000K	9,269
	5000K	9,393

Lumen Ambient Temperature (LAT) Multipliers

Use these factors to determine relative lumen output for average ambient temperatures from 0-50°C (32-122°F).

Ambient	Ambient	Lumen Multiplier
0°C	32°F	1.05
5°C	41°F	1.04
10°C	50°F	1.03
15°C	59°F	1.02
20°C	68°F	1.01
25°C	77°F	1.00
30°C	86°F	0.99
35°C	95°F	0.98
40°C	104°F	0.97

HID Replacement Guide

Luminaire	Equivalent HID Lamp	WPX Input Power
WPX1 LED P1	100W	11W
WPX1 LED P2	150W	24W
WPX2	250W	47W
WPX3	400W	69W

Emergency Egress Battery Packs

The emergency battery backup is integral to the luminaire — no external housing or back box is required. The emergency battery will power the luminaire for a minimum duration of 90 minutes and deliver minimum initial output of 550 lumens. Both battery pack options are CEC compliant.

Battery Type	Minimum Temperature Rating	Power (Watts)	Controls Option	Ordering Example
Standard	0°C	4W	E4WH	WPX2 LED 40K MVOLT E4WH DDBXD
Cold Weather	-20°C	14W	E14WC	WPX2 LED 40K MVOLT E14WC DDBXD

Photometric Diagrams

To see complete photometric reports or download .ies files for this product, visit the Lithonia Lighting [WPX LED](#) homepage. Tested in accordance with IESNA LM-79 and LM-80 standards

LEGEND

	0.1 fc
	0.2 fc
	0.5 fc
	1.0 fc

WPX1 LED P1

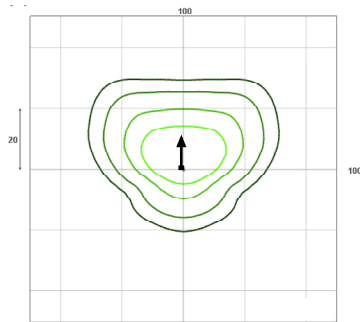

WPX1 LED P2

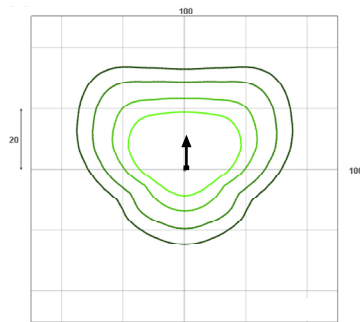

WPX2 LED

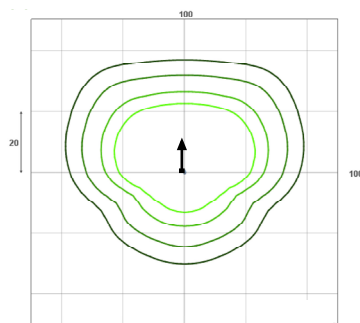

WPX3 LED

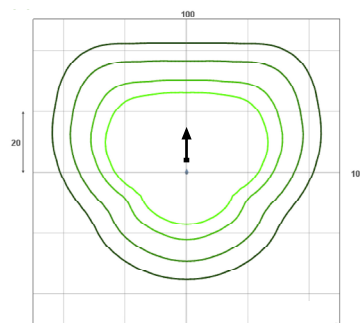

Mounting Height = 12 Feet.

GEOPAK Series 2

SIZE 2 - TRP2/QSP2/RD12

Type SB

FEATURES

- Mid sized architectural wallpacks in three stylish shapes
- Capable of replacing up to 400w HID luminaires
- Type 2, 3, 4F and 4W distributions for a wide variety of applications
- Integral battery backup options
- Control capabilities offer additional energy savings options
- Zero uplight distributions



SPECIFICATIONS

CONSTRUCTION

- Die-cast aluminum housing and door
- Seven powder coat standard finishes, plus custom color options
- Meets ASTM B117 with 1,000 hours of salt spray exposure

OPTICS

- LEDs deliver up to 15,000 lumens
- Up to 155 lumens per watt (LPW)
- Different lenses offer a variety of distribution patterns - Type 2, 3, 4F & 4W
- CCT: 3000K, 4000K, and 5000K
- CRI: 70 and 80

INSTALLATION

- Quick-mount adapter with gasket seal provides easy installation to wall or to recessed junction box (4" square junction box). Fixture attaches by two Allen-head hidden fasteners for tamper resistance
- Back box accessory available for surface conduit application

ELECTRICAL

- Optional Dual Drivers & Dual Power Feed
- 120-277, 347 and 480 voltage, 50/60Hz
- Power factor > 90%
- THD (Total Harmonic Distortion) <20%

ELECTRICAL (CONTINUED)

- Ambient operating temperature -40°C to 40°C
- Optional: 20kA surge protection device (series); Automatically takes fixture off-line when device is consumed
- Integral Battery Backup provides emergency lighting with 13W of power for the required 90 minutes for path of egress
- Independent dedicated driver and LED array for battery/emergency mode operation

CONTROLS

- Drivers are 0-10V dimming standard
- Universal button photocontrol for dusk to dawn energy savings
- Photocell and occupancy sensor options available for complete on/off and dimming control
- Dual Driver option provides 2 drivers within luminaire but only one set of leads exiting the luminaire, where Dual Power Feed provides two drivers which can be wired independently as two sets of leads are extended from the luminaire. Both options can not be included in one same fixture.

CERTIFICATIONS

- IP65 rated housing
- Zero uplight (U0), dark sky, neighbor friendly
- Drivers IP66 and RoHS compliant
- This product meets federal procurement law requirements under the Buy American Act (FAR 52.225-9) and Trade Agreements Act (FAR 52.225-11). See Buy American Solutions.

WARRANTY

- 5 year limited warranty

KEY DATA	
Lumen Range	3,500-15,000
Wattage Range	24-126
Efficacy Range (LPW)	95-154
Weights lbs. (kg)	16-18 (7.3-8.2)



DATE: _____ LOCATION: _____
 TYPE: _____ PROJECT: _____
 CATALOG #: _____

GEOPAK Series 2

SIZE 2 - TRP2/QSP2/RD12

ORDERING GUIDE

Example: TRP2-36L-25-3K7-2-UNV-DBT

CATALOG #

ORDERING INFORMATION

Series	# LEDs - Wattage	CCT/CRI	Distribution	Voltage
TRP2 Trapezoid	36L-25 4,200 Lumens (Strike)	27K8 2700K, 70 CRI	2 TYPE 2	UNV 120-277V
RD12 Radius	36L-39 5,700 Lumens (Strike)	3K7 3000K, 70 CRI	3 TYPE 3	120 120V
QSP2 Quartersphere	36L-55 7,700 Lumens (Strike)	3K8 3000K, 80 CRI	4W TYPE 4W	208 208V
	36L-85 10,300 Lumens (Strike)	4K7 4000K, 70 CRI	4F TYPE 4 Forward	240 240V
	36L-105 12,300 Lumens (Strike)	4K8 4000K, 80 CRI		277 277V
	36L-120 13,100 Lumens (Strike)	5K7 5000K, 70 CRI		347 347V
	160L-25 3,600 Lumens (Micro Strike)	5K8 5000K, 80 CRI		480 480V
	160L-35 5,500 Lumens (Micro Strike)			
	160L-50 7,700 Lumens (Micro Strike)			
	160L-75 9,700 Lumens (Micro Strike)			
	160L-100 12,000 Lumens (Micro Strike)			
	160L-115 14,600 Lumens (Micro Strike)			

Color	Control Options	Options
BLT Black Matte Textured	PC Button Photocontrol	SF ¹ Single fuse & fuse holder
BLS Black Gloss Smooth	NXW NX Wireless Radio (No Sensor)	DF ¹ Double fuse & fuse holder
DBT Dark Bronze Matte Textured	NXWS NX Wireless Sensor w/BT	E ^{2,3,4} Battery pack (0°C)
DBS Dark Bronze Gloss Smooth	BTSO Bluetooth Sensor OMNI	EH ^{2,3,4} Battery pack (-20°C) with heater
GTT Graphite Matte Textured	CD Customer Dimming	2DR ⁵ Dual Drivers
LGS Light Grey Gloss Smooth	Mount Height	2PF ^{2,5} Dual power feeds
PSS Platinum Silver Smooth	-12F Up to 12ft mount height	SP Surge Protector
WHT White Matte Textured		
WHS White Gloss Smooth		
VGT Verde Green Textured		
Color Option		
CC Custom Color		

- Notes:
- 1 Must specify voltage
 - 2 Battery option not compatible with 2 power feeds
 - 3 E and EH options available for 160L-25, 160L-35, 160L-50, 36L-25, 36L-39, and 36L-55
 - 4 E and EH available for UNV, 120, 208, 240, 277V
 - 5 Option only available with 36L-85, 36L-105, 36L-120, 160L-75, 160L-100, and 160L-115.

ACCESSORIES (ORDERED SEPARATELY)

Catalog Number	Description
<input type="checkbox"/> WP-BB-DBT	Backbox with four 1/2" threaded conduit holes painted Dark Bronze Texture

GEOPAK Series 2

SIZE 2 - TRP2/QSP2/RD12

PERFORMANCE DATA (MICRO STRIKE)

Description	Nominal Wattage	System Watts	Dist. Type	5K (5000K NOMINAL 70 CRI)					4K (4000K NOMINAL 70 CRI)					3K (3000K NOMINAL 80 CRI)				
				Lumens	LPW	B	U	G	Lumens	LPW	B	U	G	Lumens	LPW	B	U	G
160L	25	24.4	2	3734	153	1	0	1	3663	150	1	0	1	3557	146	1	0	1
			3	3744	154	1	0	1	3672	151	1	0	1	3565	146	1	0	1
			4F	3721	153	1	0	1	3651	150	1	0	1	3544	145	1	0	1
			4W	3704	152	1	0	1	3633	149	1	0	1	3528	145	1	0	1
	35	37.7	2	5602	149	1	0	2	5495	146	1	0	2	5335	142	1	0	2
			3	5616	149	1	0	2	5509	146	1	0	2	5348	142	1	0	2
			4F	5582	148	1	0	2	5476	145	1	0	2	5316	141	1	0	2
			4W	5556	147	2	0	2	5450	145	1	0	2	5291	140	1	0	2
	50	56.2	2	7880	140	1	0	2	7730	138	1	0	2	7504	134	1	0	2
			3	7899	141	1	0	2	7749	138	1	0	2	7523	134	1	0	2
			4F	7852	140	1	0	2	7703	137	1	0	2	7478	133	1	0	2
			4W	7815	139	1	0	2	7666	136	1	0	2	7443	132	1	0	2
	75	71.9	2	9971	139	2	0	2	9781	136	2	0	2	9496	132	1	0	2
			3	9996	139	2	0	2	9805	136	2	0	2	9520	132	1	0	2
			4F	9936	138	1	0	2	9747	136	2	0	2	9463	132	1	0	2
			4W	9890	138	1	0	2	9701	135	2	0	2	9419	131	1	0	2
	100	95.7	2	12361	129	2	0	2	12126	127	2	0	2	11772	123	2	0	2
			3	12392	129	2	0	2	12156	127	2	0	2	11802	123	2	0	2
			4F	12318	129	2	0	2	12083	126	2	0	2	11731	123	2	0	2
			4W	12260	128	2	0	2	12027	126	2	0	2	11676	122	2	0	2
	115	116.6	2	14990	129	2	0	2	14705	126	2	0	2	14277	122	2	0	2
			3	15088	129	3	0	2	14801	127	3	0	3	14370	123	3	0	3
			4F	14970	128	2	0	3	14685	126	2	0	3	14257	122	2	0	2
			4W	14981	128	2	0	3	14695	126	3	0	3	14267	122	2	0	3

MULTIPLIER (MICRO STRIKE)

Micro Strike Lumen Multiplier			
CCT	70CRI	80CRI	90CRI
2700K	-	0.869	-
3000K	0.945	0.832	0.626
3500K	-	0.900	-
4000K	1.027	0.951	0.718
5000K	1.000	0.937	0.791
Monochromatic Amber Multiplier			
Amber	0.719		



DATE: _____ LOCATION: _____

TYPE: _____ PROJECT: _____

CATALOG #: _____

GEOPAK Series 2

SIZE 2 - TRP2/QSP2/RD12

PERFORMANCE DATA (STRIKE)

Description	Nominal Wattage	System Watts	Dist. Type	5K (5000K NOMINAL 70 CRI)					4K (4000K NOMINAL 70 CRI)					3K (3000K NOMINAL 80 CRI)				
				Lumens	LPW	B	U	G	Lumens	LPW	B	U	G	Lumens	LPW	B	U	G
36L	25	32.1	2	4131	130	1	0	1	4208	132	1	0	1	3861	121	1	0	1
			3	4150	130	1	0	2	4227	132	1	0	2	3878	121	1	0	1
			4F	4163	130	1	0	1	4241	132	1	0	1	3891	122	1	0	1
			4W	4156	130	1	0	2	4233	132	1	0	2	3884	121	1	0	2
	39	45.1	2	5618	125	1	0	1	5723	127	1	0	1	5251	116	1	0	1
			3	5644	125	1	0	2	5749	127	1	0	2	5274	117	1	0	2
			4F	5662	126	1	0	2	5768	128	1	0	2	5291	117	1	0	2
			4W	5652	125	1	0	2	5757	128	1	0	2	5282	117	1	0	2
	55	63.1	2	7458	118	1	0	2	7659	121	1	0	2	6970	110	1	0	2
			3	7552	120	1	0	2	7694	122	1	0	2	7058	112	1	0	2
			4F	7577	120	1	0	2	7718	122	1	0	2	7081	112	1	0	2
			4W	7564	120	1	0	3	7705	122	1	0	3	7069	112	1	0	3
	85	88.0	2	10121	115	2	0	2	10311	117	2	0	2	9459	107	2	0	2
			3	10167	116	1	0	3	10357	118	1	0	3	9502	108	1	0	3
			4F	10200	116	1	0	2	10390	118	1	0	2	9532	108	1	0	2
			4W	10182	116	1	0	3	10372	118	1	0	3	9516	108	1	0	3
	105	111.7	2	12022	108	2	0	2	12247	110	2	0	2	11235	101	2	0	2
			3	12075	108	2	0	3	12301	110	2	0	3	11285	101	2	0	3
			4F	12115	108	1	0	3	12341	110	1	0	3	11322	101	1	0	2
			4W	12093	108	2	0	3	12319	110	2	0	3	11302	101	1	0	3
	120	126.2	2	12889	102	2	0	2	13130	104	2	0	2	12046	95	2	0	2
			3	12947	103	2	0	3	13189	105	2	0	3	12100	96	2	0	3
			4F	12989	103	1	0	3	13232	105	1	0	3	12139	96	1	0	3
			4W	12966	103	2	0	3	13208	105	2	0	3	12118	96	1	0	3

MULTIPLIER (STRIKE)

Strike Lumen Multiplier			
CCT	70CRI	80CRI	90CRI
2700K	0.900	0.810	0.62
3000K	0.933	0.853	0.659
3500K	0.959	0.894	0.711
4000K	1.000	0.900	0.732
5000K	1.000	0.900	0.732
Monochromatic Amber Multiplier			
Amber	0.255		



DATE: _____ LOCATION: _____

TYPE: _____ PROJECT: _____

CATALOG #: _____

GEOPAK Series 2

SIZE 2 - TRP2/QSP2/RD12

PROJECTED LUMEN MAINTENANCE

Ambient Temperature	OPERATING HOURS					
	0	25,000	TM-21-t1 36,000	50,000	100,000	L70 (Hours)
25°C / 77°F	1.00	0.97	0.96	0.95	0.91	408,000
40°C / 104°F	0.99	0.96	0.95	0.94	0.89	356,000

For Microstrike LEDs

LUMINAIRE AMBIENT TEMPERATURE FACTOR (LATF)

Ambient Temperature	Lumen Multiplier	
0°C	32°F	1.03
10°C	50°F	1.01
20°C	68°F	1.00
25°C	77°F	1.00
30°C	86°F	0.99
40°C	104°F	0.98
50°C	122°F	0.97

Use these factors to determine relative lumen output for average ambient temperatures from 0-40°C (32-104°F).

ELECTRICAL DATA

# OF LEDS	Nominal Wattage	Input Voltage	Oper. Current (Amps)	System Power (Watts)
160L	25	120	0.20	24.4
		208	0.12	
		240	0.10	
		277	0.09	
		347	0.07	
		480	0.05	
	35	120	0.31	37.7
		208	0.18	
		240	0.16	
		277	0.14	
		347	0.11	
		480	0.08	
	50	120	0.47	56.2
		208	0.27	
		240	0.23	
		277	0.20	
		347	0.16	
		480	0.12	
	75	120	0.60	72.0
		208	0.35	
		240	0.30	
		277	0.26	
		347	0.21	
		480	0.15	
100	120	0.80	95.7	
	208	0.46		
	240	0.40		
	277	0.35		
	347	0.28		
	480	0.20		
115	120	0.97	116.6	
	208	0.56		
	240	0.49		
	277	0.42		
	347	0.34		
	480	0.24		

# OF LEDS	Nominal Wattage	Input Voltage	Oper. Current (Amps)	System Power (Watts)
36L	25	120	0.27	32.1
		208	0.15	
		240	0.13	
		277	0.12	
		347	0.09	
		480	0.07	
	39	120	0.38	45.1
		208	0.22	
		240	0.19	
		277	0.16	
		347	0.13	
		480	0.09	
	55	120	0.53	63.1
		208	0.30	
		240	0.26	
		277	0.23	
		347	0.18	
		480	0.13	
	85	120	0.73	88.0
		208	0.42	
		240	0.37	
		277	0.32	
		347	0.25	
		480	0.18	
105	120	0.93	111.7	
	208	0.54		
	240	0.47		
	277	0.40		
	347	0.32		
	480	0.23		
120	120	1.05	126.2	
	208	0.61		
	240	0.53		
	277	0.46		
	347	0.36		
	480	0.26		

GEOPAK Series 2

SIZE 2 - TRP2/QSP2/RDI2

PHOTOMETRY

The following diagrams represent the general distribution options offered for this product. For detailed information on specific product configurations, see website photometric test reports.

TRP2-50W-4K7-T2

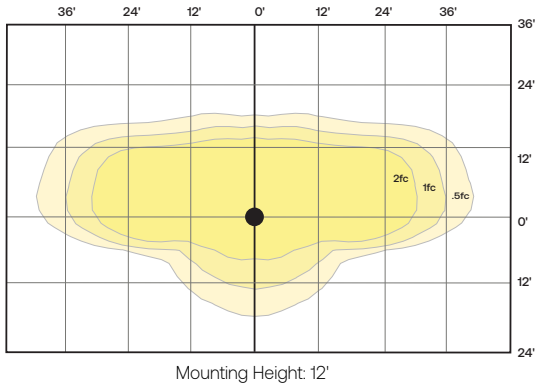

TRP2-50W-4K7-T3

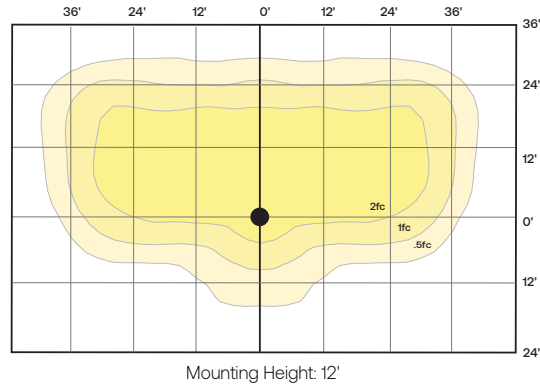

TRP2-50W-4K7-T4F

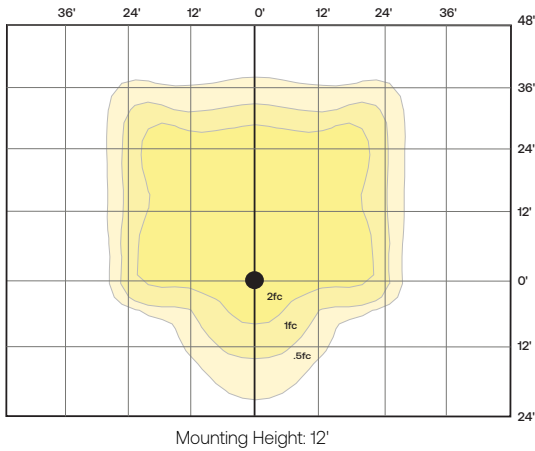

TRP2-50W-4K7-T4W

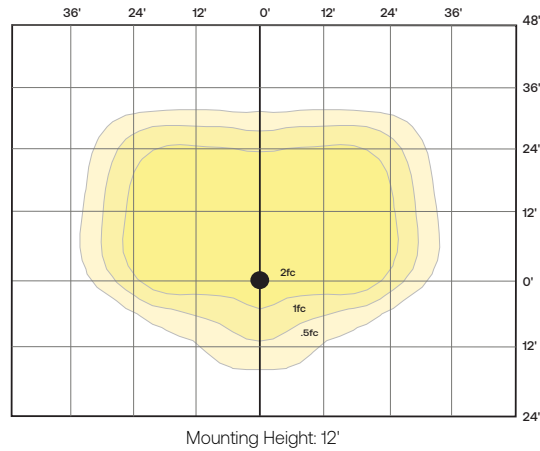

GEOPAK Series 2

SIZE 2 - TRP2/QSP2/RDI2

DIMENSIONS

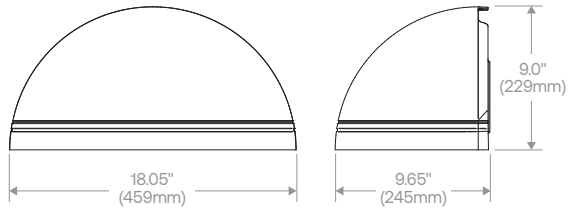

QSP2
Weight:
15 lbs (6.8 kg)

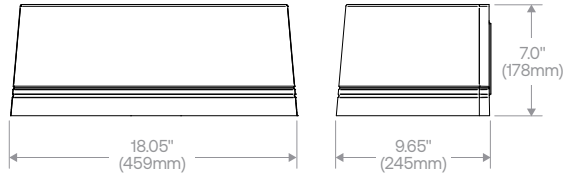

RDI2
Weight:
16 lbs (7.3 kg)

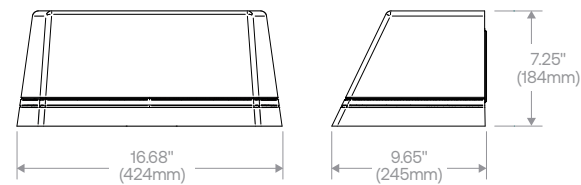

TRP2
Weight:
16 lbs (7.3 kg)

ADDITIONAL INFORMATION

PHOTOMETRICS - BATTERY BACK UP

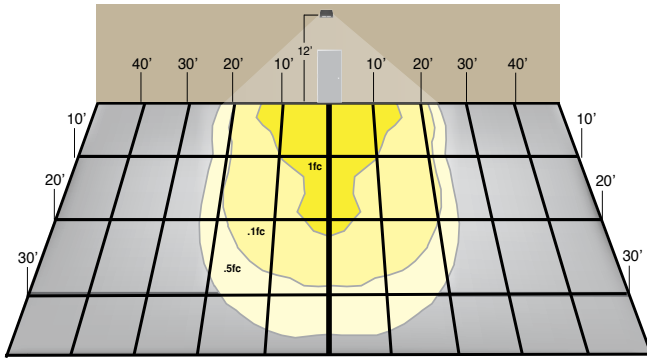

36L - 12' Mounting Height

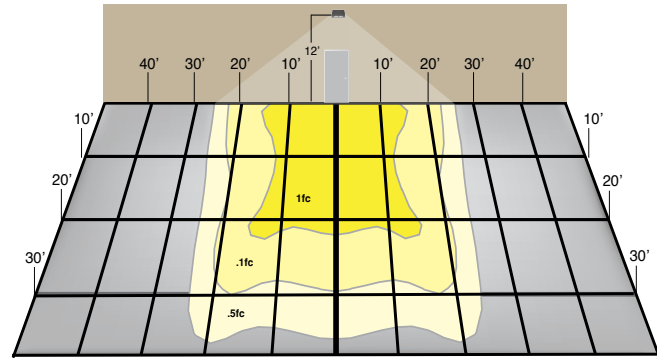

160L - 12' Mounting Height

Provides Life Safety Code average illuminance of 1.0 fc. Assumes open space with no obstructions and mounting height of 12'.

Diagrams for illustration purposes only, please consult factory for application layout.

CONTROL OPTIONS



Programmable occupancy sensor offers greater control and energy savings with adjustable delay and dimming levels (Factory default is 10%)

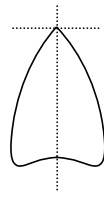

General Illumination Square Shower Downlight

6"

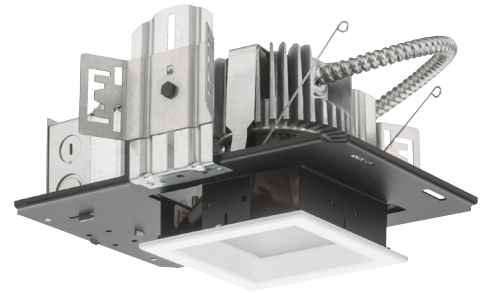

OVERVIEW

Feature Set

- Wipe down flush or regressed lens
- NSF2 Splash/Non-food Zone
- Fully serviceable and upgradeable lensed LED light engine
- 70% lumen maintenance at 60,000 hours
- 2.5 MacAdam ellipse; 85 CRI typical, 90+ CRI optional
- IP66 rated room-side, Fixtures are wet location, covered ceiling
- Anti-microbial paint finish, optional
- Non-conductive dead-front trim
- Suitable for steam room applications
- UGR of zero for fixtures aimed at nadir with a cut-off equal to or less than 60deg per CIE 117-1995 Discomfort Glare in Interior Lighting. [UGR FAQ](#)

Distribution



Superior Performance (Flush, Clear Lens)

Nominal Lumens	1000	1500	2000	2500
Delivered	870	1292	1754	2219
Wattage	9.6	14.7	19.7	24.7
Efficacy	90.6	87.9	89.0	89.8

*Lumen output for 80CRI - 3500K

COMPLEMENTARY PRODUCTS

Coordinated Apertures | Multiple Layers of Light



General Illumination Layer | EVO



High Center Beam Layer | Incito



EVO + Incito — Multiple Layers of Light

Core



Downlight



Adjustable



Open Wallwash



Lensed Wallwash



Cylinder



Pinhole



Bevel



Hyperbolic

Healthcare



MRI



Surgical Suite



Patient Room

Special Applications



Dynamic



Food Service



Vandal/Tamper



Clean Room



Shower



Steam Room

A+ Capable options indicated by this color background.

Luminaire Type:

Catalog Number:

EXAMPLE: EV06SQSH 35/20 DFRAMF SOL MVOLT EZ1

Series	Color Temperature	Nominal Lumen Values	Lens Setting	Lens	Voltage
EV06SQSH	27/ 2700 K 30/ 3000 K 35/ 3500 K 40/ 4000 K 50/ 5000 K	10 1000 lumens 15 1500 lumens 20 2000 lumens 25 2500 lumens	DFR Regressed lensed white painted trim DFR Flush lensed white painted trim DFRBR Regressed lensed black painted trim DFRBR Flush lensed black painted trim DFRAMF Regressed lensed trim with anti-microbial finish DFRAMF Flush lensed trim with anti-microbial finish	SOL Textured Lens SMO Smooth Clear Lens	MVOLT 120 277

Driver ¹	Control Interface	Emergency	Options
EZ1 eldoLED 0-10V ECOdrive. Linear dimming to 1% min. EZB eldoLED 0-10V SOLOdrive. Logarithmic dimming to <1%. EDAB eldoLED SOLOdrive DALI. Logarithmic dimming to <1%.	NLT² nLight™ dimming pack controls NLTER^{2,3} nLight™ dimming pack controls emergency circuit	(blank) no emergency option ELR⁴ Emergency battery pack, 10W, with remote test switch. E10WCPR⁴ Emergency battery pack, 10W Constant Power, CA Title 20 compliant with remote test switch BGTD Bodine generator transfer device. Specify 120V or 277V.	SF Single fuse. Specify 120V or 277V. 90CRI High CRI (90+). CP Chicago Plenum. Specify 120V or 277V.

ACCESSORIES — order as separate catalog numbers (shipped separately)

ISD BC 0-10V wallbox dimmer. Refer to [ISD-BC](#).

ORDERING NOTES

1. Refer to [TECH-240](#) for compatible dimmers.
2. Specify voltage.
3. For use with generator supply EM power. Will require an emergency hot feed and normal hot feed.
4. Not available with CP option.

Optical Assembly

Fully serviceable and upgradeable lensed LED light engine, both the driver and light engine are suitable for field maintenance and are serviceable from above or below the ceiling.

Unitized optics shall have mechanical attachment of the light engine to the lower reflector for complete optical alignment.

Electrical

The luminaire shall operate from a 50 or 60 Hz ±3 Hz AC line over a voltage ranging from 120 VAC to 277 VAC. The fluctuations of line voltage shall have no visible effect on the luminous output.

The luminaire shall have a power factor of 90% or greater at all standard operating voltages and full luminaire output.

Sound Rated A+. Driver shall be >80% efficient at full load across all input voltages.

Input wires shall be 18AWG, 300V minimum, solid copper. All drivers are ROHS compliant.

Controls

Luminaire shall be equipped with interface for nLight wired network with integral power supply as per specification.

Dimming

The luminaire shall be capable of continuous dimming without perceivable stroboscopic flicker as measured by flicker index (ANSI/IES RP-16-10) over a range of 100 – 10%, 100 – 1.0% or 100 – 0.1% of rated lumen output with a smooth shut off function to step to 0%.

eldoLED LED drivers shall conform to IEEE P1789 standards. Alternatively, manufacturers must demonstrate conformance with product literature and testing which demonstrates this performance. Systems that do not meet IEEE P1789 will not be considered.

Driver is inaudible in 24dB environment, and stable when input voltage conditions fluctuate over what is typically experienced in a commercial environment.

Construction

Luminaire housing shall be constructed of 16-gauge galvanized steel and have preinstalled telescopic mounting bars with maximum 32" and minimum 15" extension and 4" vertical adjustment.

Luminaires shall be suitable for installation in ceilings up to 1½" thick.

Tool-less adjustments shall be possible after installation.

The assembly and manufacturing process for the luminaire shall be designed to assure all internal components are adequately supported to withstand mechanical shock and vibration.

25°C ambient temperature standard (1/2" clearance on all sides from non-combustible materials in non-IC applications, unless marked spacing noted otherwise). For use in insulated ceilings, a 3" clearance on all sides from insulation is required (unless marked spacing noted otherwise).

Listings

Fixtures are CSA certified to meet US and Canadian standards: All fixtures manufactured in strict accordance with the appropriate and current requirements of the "Standards for Safety" to UL, wet location covered ceiling.

Photometrics

LEDs tested to LM-80 standards. Measured by IESNA Standard LM-79-08 in an accredited lab. Lumen output shall not decrease by more than 30% over the minimum operational life of 60,000 hours.

Color appearance from luminaire to luminaire of the same type and in all configurations, shall be consistent both initially and at 60,000 hours and operate within a tolerance of <2.5 MacAdam ellipse as defined by a point at the intersection of the CCT line and the black body locus line in CIE chromaticity space.

Buy American Act

This product is assembled in the USA and meets the Buy America(n) government procurement requirements under FAR, DFARS and DOT regulations. Please refer to www.acuitybrands.com/buy-american for additional information.

Warranty

5-year limited warranty. This is the only warranty provided and no other statements in this specification sheet create any warranty of any kind. All other express and implied warranties are disclaimed. Complete warranty terms located at: www.acuitybrands.com/support/warranty/terms-and-conditions

Note:

Actual performance may differ as a result of end user environment and application. All values are design or typical values, measured under laboratory conditions at 25 °C.

A+ Capable Luminaire

This item is an A+ capable luminaire, which has been designed and tested to provide consistent color appearance and out-of-the-box control compatibility with simple commissioning.

- All configurations of this luminaire meet the Acuity Brands' specification for chromatic consistency
- This luminaire is part of an A+ Certified solution for nLight® control networks when ordered with drivers marked by a shaded background*
- This luminaire is part of an A+ Certified solution for nLight® control networks, providing advanced control functionality at the luminaire level, when selection includes driver and control options marked by a shaded background*

To learn more about A+, visit www.acuitybrands.com/aplus.

*See ordering tree for details

DIMENSIONAL DATA

*Dimensions in inches [centimeters]

Aperture: 6 1/4" [15.9]	Ceiling Opening: 7 1/8" [18.1] self-flanged
Overlap Trim: 7 1/2" [19.1]	7 1/4" [18.4] flangeless

Standard

weight:
Housing = 7.8 lbs
Trim = 0.9 lbs

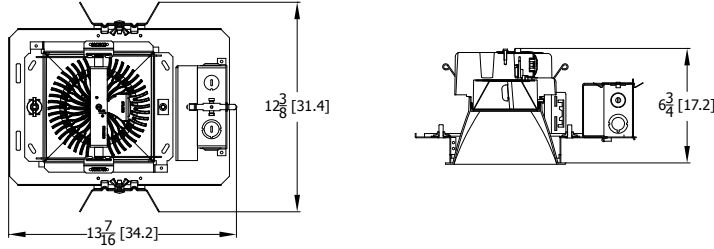

Battery Pack

Weight: Battery only = 2.5 lbs

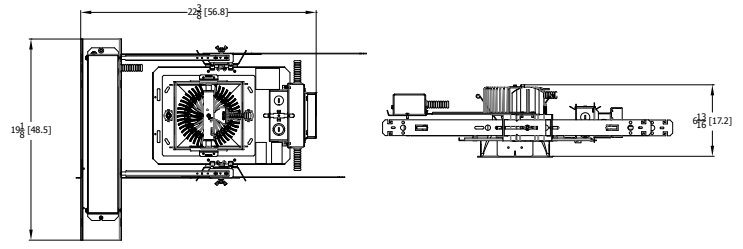

CP

Weight: CP housing only = 13 lbs

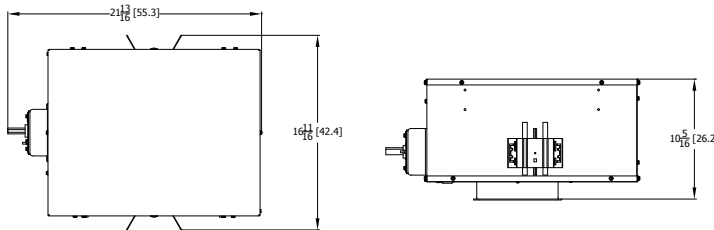

EVO - eldoLED Driver Default Dimming Curve			
Nomenclature	Min Dimming	Driver Dim Curve	Control Dim Curve
EZ1	1%	Linear	Linear/Logarithmic
EXA1	1%	Linear	Linear/Logarithmic
EZB	<1%	Logarithmic	Linear
EDAB	<1%	Logarithmic	Linear
EXAB	<1%	Logarithmic	Linear
EDXB	<1%	Logarithmic	Linear

Driver		Control Provided (note: 347V/UVOLT versions provided with 347 option selected)	
Nomenclature	Description	NLT	NLTER
GZ10	0-10V driver dims to 10%	nPP16 D EFP	nPP16 D ER EFP
GZ1	0-10V driver dims to 1%	nPP16 D EFP	nPP16 D ER EFP
EZ1	eldoLED 0-10V ECOdrive	nPS 80 EZ	nPS 80 EZ ER
EZB	eldoLED 0-10V SOLOdrive	nPS 80 EZ	nPS 80 EZ ER

How to Estimate Delivered Lumens in Emergency Mode

Delivered Lumens = 1.25 x P x LPW

P = Output power of emergency driver. P = 10W for PS1055CP

LPW = Lumen per watt rating of the luminaire. This information is available on the ABL luminaire spec sheet.

Photometry

EV06SQSH 35/25 DFF SMO 80CRI INPUT WATTS: 24.7W, DELIVERED LUMENS: 2219.5LM, LPW = 90, 0.87 S/MH, TEST NO: LTL29890P89

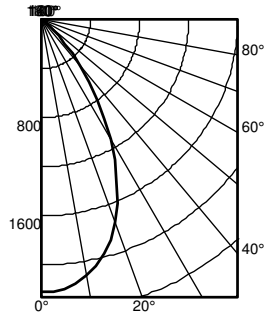

Ave	Lumens	Zone	Lumens	% Lamp
0	2222	0° - 30°	1420.1	64.0
5	2200	0° - 40°	1915.2	86.3
15	1980	0° - 60°	2192.7	98.8
25	1456	0° - 90°	2218.6	100.0
35	795	90° - 120°	0.0	0.0
45	274	90° - 130°	0.0	0.0
55	56	90° - 150°	0.3	0.0
65	16	90° - 180°	0.9	0.0
75	7	0° - 180°	2219.5	*100.0
85	2			
90	0			

Mounting Height	Initial FC		50% beam -		10% beam -	
	Center Beam	Diameter	FC	Diameter	FC	FC
8.0	73.5	5.0	36.7	9.3	7.3	
10.0	39.5	6.9	19.7	12.6	3.9	
12.0	24.6	8.7	12.3	16.0	2.5	
14.0	16.8	10.5	8.4	19.4	1.7	
16.0	12.2	12.4	6.1	22.7	1.2	

EV06SQSH 35/25 DFF SOL 80CRI INPUT WATTS: 24.7W, DELIVERED LUMENS: 2124.7LM, LPW = 86, 0.96 S/MH, TEST NO: LTL29889P89

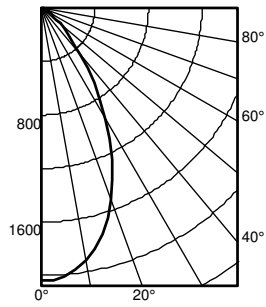

Ave	Lumens	Zone	Lumens	% Lamp
0	2040	0° - 30°	1243.3	58.5
5	2015	0° - 40°	1673.6	78.8
15	1752	0° - 60°	2013.1	94.7
25	1247	0° - 90°	2124.7	100.0
35	688	90° - 180°	0.0	0.0
45	292	0° - 180°	2124.7	*100.0
55	116			
65	62			
75	36			
85	10			
90	2			

Mounting Height	Initial FC		50% beam -		10% beam -	
	Center Beam	Diameter	FC	Diameter	FC	FC
8.0	67.4	4.8	33.7	9.3	6.7	
10.0	36.3	6.6	18.1	12.6	3.6	
12.0	22.6	8.3	11.3	16.0	2.3	
14.0	15.4	10.1	7.7	19.4	1.5	
16.0	11.2	11.8	5.6	22.7	1.1	

EV06SQSH 35/25 DFR SMO 80CRI INPUT WATTS: 24.7W, DELIVERED LUMENS: 1820.8LM, LPW = 73.7, 0.9 S/MH, TEST NO: LTL29892P93

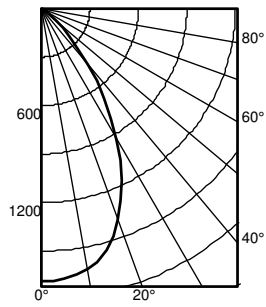

Ave	Lumens	Zone	Lumens	% Lamp
0	1690	0° - 30°	1123.6	61.7
5	1677	0° - 40°	1547.6	85.0
15	1550	0° - 60°	1800.7	98.9
25	1172	0° - 90°	1820.8	100.0
35	683	90° - 180°	0.0	0.0
45	251	0° - 180°	1820.8	*100.0
55	50			
65	12			
75	6			
85	1			
90	0			

Mounting Height	Initial FC		50% beam -		10% beam -	
	Center Beam	Diameter	FC	Diameter	FC	FC
8.0	55.9	5.2	27.9	9.6	5.6	
10.0	30.0	7.1	15.0	13.1	3.0	
12.0	18.7	9.1	9.4	16.6	1.9	
14.0	12.8	11.0	6.4	20.1	1.3	
16.0	9.3	12.9	4.6	23.6	0.9	

EV06SQSH 35/25 DFR SOL 80CRI INPUT WATTS: 24.7W, DELIVERED LUMENS: 1655LM, LPW = 67, 0.85 S/MH, TEST NO: LTL29891P89

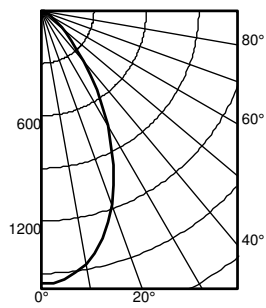

Ave	Lumens	Zone	Lumens	% Lamp
0	1560	0° - 30°	962.8	58.2
5	1539	0° - 40°	1309.3	79.1
15	1349	0° - 60°	1586.5	95.9
25	972	0° - 90°	1655.0	100.0
35	554	90° - 180°	0.0	0.0
45	242	0° - 180°	1655.0	*100.0
55	93			
65	44			
75	20			
85	2			
90	0			

Mounting Height	Initial FC		50% beam -		10% beam -	
	Center Beam	Diameter	FC	Diameter	FC	FC
8.0	51.6	4.9	25.8	9.5	5.2	
10.0	27.7	6.6	13.9	12.9	2.8	
12.0	17.3	8.4	8.6	16.3	1.7	
14.0	11.8	10.2	5.9	19.8	1.2	
16.0	8.6	12.0	4.3	23.2	0.9	

DFF SMO - Flush Clear				
Nominal Lumens	1000	1500	2000	2500
Delivered	870	1292	1754	2219
Wattage	9.6	14.7	19.7	24.7
Efficacy	90.6	87.9	89.0	89.8

*Lumen output for CRI80 - 3500K

DFF SOL - Flush Textured				
Nominal Lumens	1000	1500	2000	2500
Delivered	833	1238	1680	2125
Wattage	9.6	14.7	19.7	24.7
Efficacy	86.8	84.2	85.3	86.0

*Lumen output for CRI80 - 3500K

DFR SMO - Flush Clear				
Nominal Lumens	1000	1500	2000	2500
Delivered	714	1061	1440	1821
Wattage	9.6	14.7	19.7	24.7
Efficacy	74.4	72.2	73.1	73.7

*Lumen output for CRI80 - 3500K

DFR SOL - Regressed Textured				
Nominal Lumens	1000	1500	2000	2500
Delivered	649	964	1309	1655
Wattage	9.6	14.7	19.7	24.7
Efficacy	67.6	65.6	66.4	67.0

*Lumen output for CRI80 - 3500K

CCT/CRI Multiplier Table		
CRI	CCT	Multiplier
80	2700K	0.96
	300K	1.00
	3500K	1.00
	4000K	1.01
	5000K	1.07
90	2700K	0.80
	300K	0.83
	3500K	0.85
	4000K	0.87
	5000K	0.91

nLIGHT

nLight® The nLight® solution is a digital networked lighting control system that provides both energy savings and increased user configurability by cost effectively integrating time-based, daylight-based, sensor-based and manual lighting control schemes.

nLight® Wired Control Accessories

Order as separate catalog number. Visit [nLight](#).

Wall Switches

	Model Number
On/Off single pole	nPODM (color)
On/Off two pole	nPODM 2P (color)
On/Off & raise/lower single pole	nPOD DX (color)
On/Off & raise/lower two pole	nPODM 2P DX (color)
Graphic touchscreen	nPOD GFX (color)

PhotoCell Controls

Dimming	nCM ADCX
---------	----------

nLight® Wired Control Accessories (cont.)

Occupancy Sensors (PIR/dual tech)

	Model Number
Small motion 360°, ceiling	nCM 9 / nCM PDT 9
Large motion 360°, ceiling	nCM 10 / nCM PDT 10
Wide View	nWV 16 / nWV PDT 16
Wall switch with raise/lower	nWSX LV DX / nWSX PDT LV DX

Cat-5 Cables (plenum rated)

10', CAT5	CAT5 10FT J1
15', CAT5	CAT5 15FT J1

Possibilities for nLight® wired

Fixtures ordered *without* the NLT option

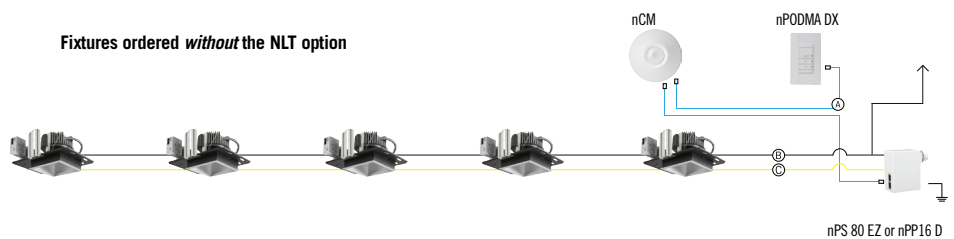

Fixtures ordered *with* the NLT option

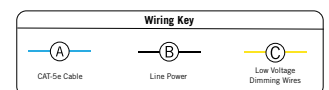
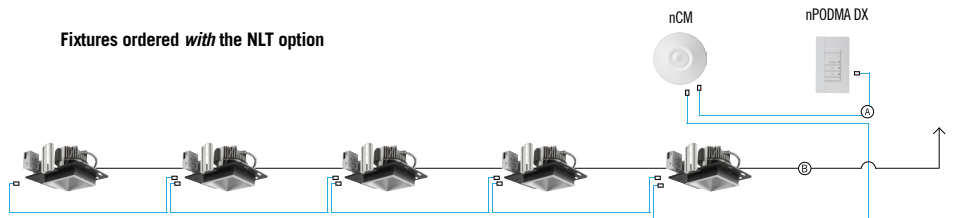

SOLID STATE LIGHTING

TORNADO SERIES-LED

SPECIFICATIONS

HOUSING

Durable corrosion resistant low copper cast aluminum alloy A356 (<0.2% Cu) having a minimum wall thickness of 1/4". Top is crowned for water run off, and retainer screw cavities are open for drainage. Top is fully gasketed and secured by (4) stainless steel allen screws. Access Panel(s) is fully gasketed and retained by (2) stainless steel allen screws located below the lens. Body secures to Mounting Stanchion by means of a cast aluminum wedge lock secured by a single stainless steel bolt and accessed through the access panel.

LED OPTICAL MODULE

Low copper A356 alloy (<.2% copper) cast aluminum housing. Integrated clear tempered 3/16" glass lens sealed with a continuous silicone gasket protects emitters (LED's) and emitter Reflector-Prism optics, and seals the module from water intrusion and environmental contaminants. LED's are available in standard Neutral White (4000K), or optional Cool White (5000K) or Warm White (3000K). Each emitter is optically controlled by a Reflector-Prism injection molded from H12 acrylic (3 types per module; one from 0° - 50°; one from 50° - 65°; one from 65° - 72°). Each Reflector-Prism has indexing pins for aiming and is secured to an optical plate made of matte black anodized aluminum. The optical plate locates every Reflector-Prism over an emitter. Reflector-Prisms are secured to the optical plate with a UV curing adhesive. The Reflector-Prisms are arrayed to produce IES Type II, IES Type III, IES Type IV, and IES Type V-SQ distributions. The entire Optical Module is field rotatable in 90° increments. Both module and drivers are factory wired using water resistant, insulated cord. Lens, module and drivers are field replaceable.

LED EMITTERS

High Output LED's are driven at 350mA for nominal 1 Watt output each. LED's are available in standard Neutral White (4000K), or optional Cool White (5000K) or Warm White (3000K). Consult Factory for other LED options.

LED DRIVER

UL and CUL recognized High Power Factor, Constant Current LED drivers operate on input voltages from 120-277VAC, 50/60hz. Consult Factory for 347-480VAC. Driver is mechanically fastened to a retaining bracket. Main power quick disconnect provided. Driver has a minimum 4KV of internal surge protection, 10KV & 20KV Surge Protector optional. Dimming and High-Low Driver options available.

FINISH

Electrostatically applied TGIC Polyester Powder Coat on substrate prepared with 20 PSI power wash at 140°F. Four step iron phosphate pretreatment for protection and paint adhesion. 400°F bake for maximum hardness and durability. Texture finish is standard.

PROJECT NAME: _____

FIXTURE TYPE: _____

Type SD

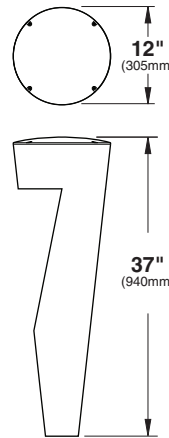

TNA*

* SHOWN WITH RIBBED ACCESS PANEL -RAP PATENT PENDING

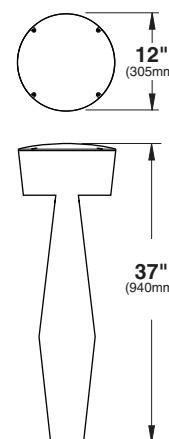

TNS

PATENT PENDING

MADE IN THE
USA

2023080

TORNADO SERIES - LED

S P E C I F I C A T I O N S

PANEL OPTIONS

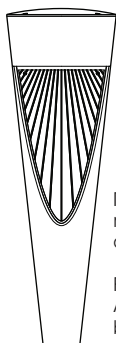

RAP Raised Access Panel

Raised ribs in radiating pattern on Access Panel.

For TNS, both Access Panels will be raised.

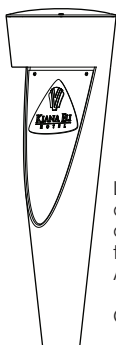

Signature Medallion

Logos, medallions and other symbols can be attached to the standard smooth Access Panel.

Consult factory.

MOUNTING STANCHION

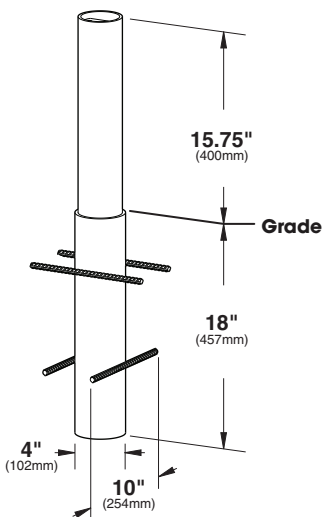

3½" SCH40 STEEL PIPE (below grade) WELDED TO 3" SCH 40 STEEL PIPE (above grade). (4) SECTIONS OF REINFORCING BAR WELDED TO LOWER PIPE FOR TIE-IN TO PAVING AND FOOTING STEEL BY OTHERS. ENTIRE ASSEMBLY IS HOT DIPPED GALVANIZED.

LED® MODULES

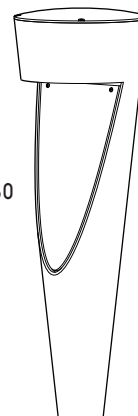

TNA E.P.A. = 1.30
Available in:
24 LED Module

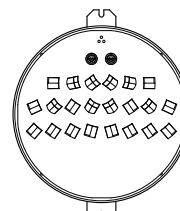

24 LED Module

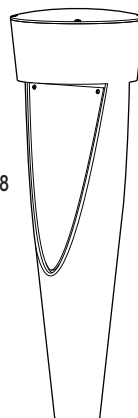

TNS E.P.A. = 1.18
Available in:
28 LED Module

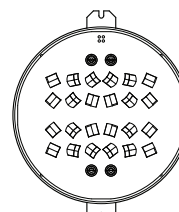

28 LED Module

O R D E R I N G I N F O R M A T I O N

LUMINAIRE	OPTICS	# of LED's	COLOR	VOLTAGE	FINISH	OPTIONS
LUMINAIRE	OPTICS	LED		FINISH	OPTIONS	
LUMINAIRE	LED® DISTRIBUTION TYPE	No. LEDs	COLOR	VOLTAGE	STANDARD TEXTURED FINISH	
<input type="checkbox"/> TNA-LED	TNA	TNA	<input type="checkbox"/> NW (4000K)* *STANDARD	<input type="checkbox"/> 120	<input type="checkbox"/> BLACK RAL-9005-T	<input type="checkbox"/> RAISED ACCESS - PANEL RAP
<input type="checkbox"/> TNS-LED	ASY	<input type="checkbox"/> 24LED (28 Watts)	<input type="checkbox"/> CW (5000K)	<input type="checkbox"/> 208	<input type="checkbox"/> WHITE RAL-9003-T	<input type="checkbox"/> DIMMABLE DRIVER(S) (0-10V) DIM
	TNS	TNS	<input type="checkbox"/> WW (3000K)	<input type="checkbox"/> 240	<input type="checkbox"/> GREY RAL-7004-T	<input type="checkbox"/> HIGH-LOW DIMMING FOR HARDWIRED SWITCHING OR NON-INTEGRATED MOTION SENSOR HLSW
	SYM	<input type="checkbox"/> 28LED (32 Watts)	OTHER LED COLORS AVAILABLE CONSULT FACTORY	<input type="checkbox"/> 277	<input type="checkbox"/> DARK BRONZE RAL-8019-T	<input type="checkbox"/> 10KV SURGE PROTECTOR 10SP
		Wattages are Max Input Watts		<input type="checkbox"/> 347	<input type="checkbox"/> GREEN RAL-6005-T	<input type="checkbox"/> 20KV SURGE PROTECTOR (277V & 480V Only) ... 20SP
				<input type="checkbox"/> 480	FOR SMOOTH FINISH REMOVE SUFFIX "T" (EXAMPLE: RAL-9500)	
					SEE USALTG.COM FOR ADDITIONAL COLORS	



COUNTY OF SAN MATEO - PLANNING AND BUILDING DEPARTMENT

ATTACHMENT D







Coastside Fire Protection District - Station 44
9/2019 Tom Vance photo



COUNTY OF SAN MATEO - PLANNING AND BUILDING DEPARTMENT

ATTACHMENT E

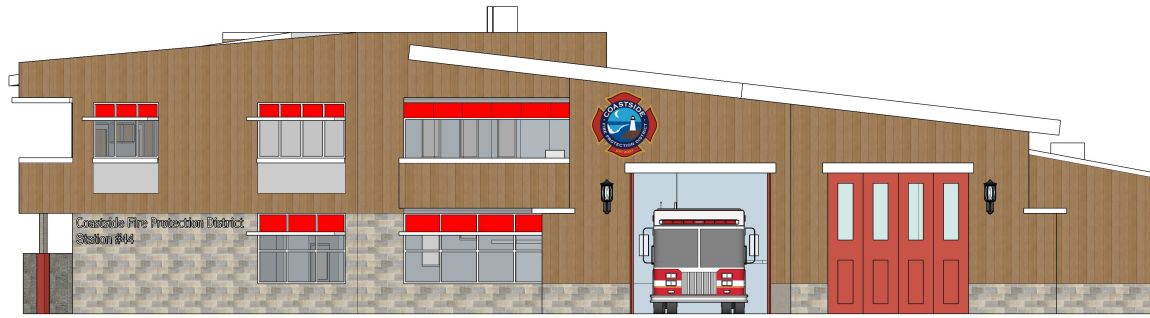

STATION IDENTIFICATION:



EXTERIOR STYLES/COLORS



VERTICAL PLANK SIDING
NICHIIA VINTAGEWOOD
CEDAR



WINDOW PANELS
JAMES HARDIE
LIGHT MIST



REFLECTION BRICK®
MASONRY UNITS
ENCHANTMENT

PAINT COLORS

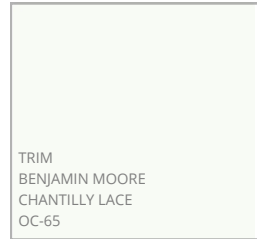

TRIM
BENJAMIN MOORE
CHANTILLY LACE
OC-65

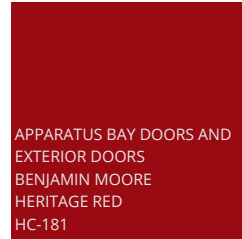

APPARATUS BAY DOORS AND
EXTERIOR DOORS
BENJAMIN MOORE
HERITAGE RED
HC-181

SPANDREL COLOR



RAL 3002
CARMINE RED

PRODUCT INSPIRATION

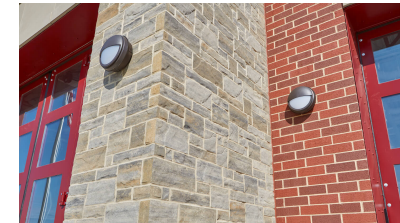

COASTSIDE FIRESTATION #44 - EXTERIOR FINISHES

FINISHES SELECTED ON

APPROVED ON:





COUNTY OF SAN MATEO - PLANNING AND BUILDING DEPARTMENT

ATTACHMENT F

1327 Archer Street
Suite 110
San Luis Obispo, California 93401
Phone: 805-329-3076
PBK.com

6/10/2024

VIA: Email



Attn: San Mateo Planning Department

Re: Planning Re-submittal, Response Letter

COMMENT: Suggested changing the upper floor white sidings/paint to earth-tone, non-reflective colors/materials.

RESPONSE: See updated exhibit with updated exterior materials. The exterior colors have been revised to eliminate the white siding and feature more of an earth tone scheme.

COMMENT: Requested additional information, such as lighting specs and updated lighting plan

RESPONSE: See updated light plan (E1.1P) and data fixture sheets.

COMMENT: Suggested relocation of the apparatus bays to the north side to reduce impacts on denser south side.

RESPONSE: This comment would be impactful to the overall design of the project, especially the return/response drive design.

1. Return Drive & Public Safety – Due to the shape of the site, if the apparatus bays are relocated to the north side, we won't have the space required to accommodate a return driveway around the back of the station. The return driveway is a critical component to the design of a modern fire station and provides a benefit to the community and public safety. It allows for an efficient return to the station without needing to block the street to back-in as they currently do. This allows for better visibility, reduces the potential for an accident in front of the station, and gets trucks off the street more efficiently with more preparation time for the next response. If the return driveway is removed, backing into the station would be required which happens at a higher decibel level, and if a significant earthquake or other disaster were to occur apparatus could block access to the site.
2. Functionality – If we were to shift the building behind the front setback, it would put a huge strain on the ability of the station to function in an ideal capacity. In addition to losing the return driveway, the station would lose multiple staff parking stalls, and no longer be able to fit all staff vehicles on site. The rear work yard would be negatively impacted, reducing the effectiveness of the staff on site to prepare and respond.

COMMENT: Concerned with hazardous fumes from hazmat equipment and engine emission

RESPONSE: The new station will be an improvement from the existing situation. First, the new engines for this station use a def-system, known as clean diesel, lower emissions. Secondly, the drive-thru return feature improves emissions as well. Engines have lower emissions when idling through a return vs. accelerating back and up into a bay.

COMMENT: Public health concerns related to noise and lighting.

RESPONSE:

1. Lighting - Very careful attention has been given to the lighting design of this station. The feedback received from MCC was understandable and has influenced our redesign. Please reference the updated site lighting plan on sheet E1.1P. The intent of the Fire District is to blend in with existing conditions and avoid any harsh light that would disturb neighbors and wildlife as noted by the MCC, while still meeting at least the minimum lighting requirements needed to safely light the site. Our updated design includes lighting fixtures mounted on the retaining walls preventing light from spilling over into the neighboring houses. However, in the case of an emergency it is vital that the fire station has the proper lighting to help ensure the community is safe. We included pole mounted lights in the back to ensure that the station is properly lit during an emergency. The emergency lighting will be on a key system and only be activated during emergencies. Please understand that the site lights have been reduced to minimize light spill with the wall mounted lights. Also, the light to the left of the response drive has been removed and replaced with a light bollard.
2. Noise - The apparatus bay will be exhausted with an inline fan that will be mounted in the attic space of the building and ducted up through the roof. The advantage of this approach is that the motor will be internal to the building and any noise from the exhaust motor will be captured within the attic space and will not be noticeable by the community. The exhaust fan will run when trucks return to the apparatus bay to remove contaminants from the air and preserve a healthy workspace for the fire fighters.

Construction noise / pollution mitigation: As part of the building permit submittal, our technical specifications will clearly describe the precautions that must be taken during construction to minimize hazards / pollution / noise within and around the job site. Typical remedies include monitoring jobsite noise levels, specifying allowable work hours during daytime, alerting the neighborhood ahead of any noisy activities, use of quiet machinery, Dust control, fencing, and sound barriers.

COMMENT: Suggested that the CFPD erect sound walls for noise reduction.

RESPONSE: The current design has effectively addressed the issue of noise pollution on site in comparison to the existing station. One major improvement lies in the addition of the return drive, which has eradicated the need for engines to emit loud alerting beeps while reversing. This alteration has significantly reduced noise levels in the vicinity. Furthermore, the installation of exhaust fans with inline motors has contained noise within the building walls, thus preventing external disturbances. The addition of 15-foot-high retaining walls has also played a crucial role in

minimizing sound transmission from trucks, generators, and crew working in the back area, a feature that is absent at the current site.

COMMENT: The proposed perm. Station is too big (3x existing).

RESPONSE: The fire station as sized is required to provide a facility that is equipped to serve the community and accommodate the health, safety, and wellness standards for the fire fighters necessary in a modern fire house. By including features such as individual bedrooms, fitness room, kitchen/dining, and dayroom spaces, the fire station not only promotes the health and wellness of its personnel, but also creates a supportive and engaging environment. A smaller station would impact response times and compromise firefighter safety and wellness. Ultimately, the goal is to provide excellent service for the community, and a modern fire station is necessary to achieve that.

COMMENT: Suggested that the perm. Station be moved to the site for the temp. station and demanded an alternative site analysis from CFPD.

RESPONSE: The fire protection board assigned staff to investigate the availability of alternative sites for acquisition, but after thorough research, it was concluded that no other options were viable. CFPD Division Chief Gary Silva canvassed the community surrounding the site and found widespread support for reconstructing the station at the current site. Additionally, the District explored the possibility of siting the new station at the temporary facility site and found doing so would be impractical and financially infeasible due to land acquisition costs and extensive land use changes that would be required. Therefore, it was decided that the current site is the most suitable option.

COMMENT: Suggested that the contractors of CFPD to coordinate with Cypress Point contractors due to their adjacency (to avoid traffic...)

RESPONSE: If construction overlaps on these projects, we will do our best to coordinate with the Cypress Point contractors and keep in consideration the possibility of increased traffic in the area. This will be noted in the project specifications.

COMMENT: CFPD is still working on a revised lighting plan and preparing response to some of the comments above. For these reasons, MCC requested that the 6/26 PC hearing be postponed.

RESPONSE: We would like to keep the schedule as planned and proceed with the PC hearing on 6/26.